

# Polaris

## User's Guide

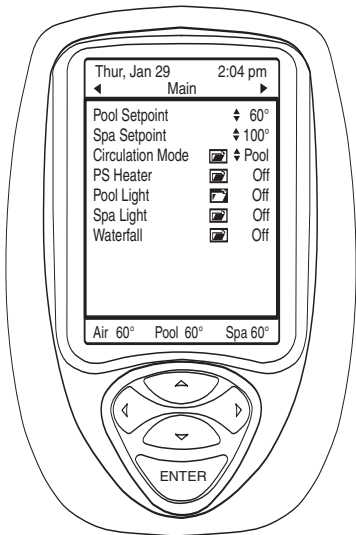

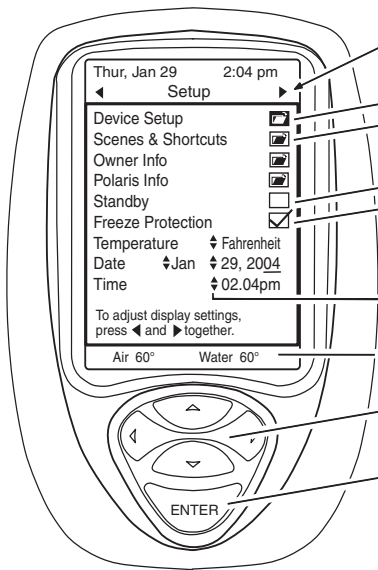

Left/right keys  
change screens

Folder Icon  
(Selected)  
(Not Selected)

Check Box  
(Off)  
(On)

Up/down keys  
change settings

Current Status or  
Alarm Messages

Cursor Control  
(Arrow) Keys

Item Select

The Polaris Eos® display screens direct all operations of the Eos automated control system.

Devices and functions are defined on the **Setup** screen during installation.

Measurements and settings are displayed on the **Main** screen or the optional device **Control** screens.

Device schedules, freeze protection, manual operation, etc. are specified on the **Device Manager** screens.

Use the arrow keys to move through screens and menu options. Press <Enter> to select an item. To adjust contrast or brightness, press the left and right arrow keys simultaneously.

For complete information, refer to the Polaris Eos Owner's Manual.



**Folders** indicate additional screens for an item.



**Check boxes** turn functions on or off.



Indicates an adjustment option, use the up/down arrow keys to select or enter a setting.

To set or adjust an item:

1. Use the arrow keys to move the cursor over the item.
2. Press <Enter> to select the item. The item will flash.
3. Use the up/down arrow keys to choose or enter the setting.
4. Press <Enter> to activate the setting.

Thur, Jan 29 2:04 pm  
 Main

Pool Setpoint 60°  
 Spa Setpoint 100°  
 Circulation Mode Pool  
 PS Heater Off  
 Pool Light Off  
 Spa Light Off  
 Waterfall Off

Air 60° Pool 60° Spa 60°

Designated Heater Temperature  
 Circulation Pump Mode or Status  
 Device Status  
 Device Folders  
 Current Temperatures

Select device folder to open Device Manager

Thur, Jan 29 2:04 pm  
 PS Heater Manager

PS Heater Off

Manual Control  
 Duration Remaining  
 24h 00m 00h 00m

Schedules

Day	Start	Stop
off	12:00p	12:00p
off	12:00p	12:00p
off	12:00p	12:00p
off	12:00p	12:00p

Heater Cool Down   
 Freeze Protect

Air 60° Pool 60° Spa 60°

Current Device Status  
 Device Activation Schedules  
 Device-Specific Functions



**USA: 2620 Commerce Way, Vista, CA 92081-8438 • 760-599-9600 • 1-800-VAC-SWEEP** (USA and Canada only)

Australia: Unit 4, 19-21 Gibbes Street, Chatswood, NSW 2067 • 02-9882-1111 • ACN 080 168 092

Europe: C/Osona s/n. (Pol. Ind. El Ramassar), 08520 Les Franqueses del Vallés, Barcelona, Spain • +34 93 840 25 85

[www.polarispool.com](http://www.polarispool.com)

©2004 Polaris Pool Systems. All rights reserved.TL-552 4/04

# Owner's Manual



---

Personalized Automated Control System

# Important Information

## **WARNING: RISK OF ELECTRICAL SHOCK.**

- **Read and follow operation and maintenance instructions carefully.**
- Electrical work should be performed by a licensed electrician and conform to all national, state and local codes.
- Do not have equipment serviced if precipitation is present or imminent.
- Always keep command center door closed when not accessing display panel.
- Do not allow children to handle this product.
- The Eos Wireless Remote requires a fully charged battery at startup. **Charge battery for at least 5 hours before use.** An inadequate charge can permanently damage the battery.

## **For customer service or support:**

- Please mail Warranty Card immediately.
- For on-line support: [www.polarispool.com](http://www.polarispool.com)
- To contact Polaris:

### **US and Canada**

Customer Service  
2620 Commerce Way  
Vista, CA 92081-8438  
1-800-822-7933

# Introduction



Congratulations on the purchase of your new automated control system and thank you for choosing Polaris. Designed to provide easy and convenient control of most pool and spa functions, the Polaris Eos Command Center:

- Controls pool and spa equipment, waterfalls, fountains, and lighting.
- Schedules regular pool and spa routines such as cleaning and circulation.
- Can be programmed to operate multiple devices with the touch of a single button.
- Components, options and functions can be expanded after installation is complete.
- Operates independently or can be remotely controlled from optional in-house wired remotes, wireless remotes or the Shortcut spa-side remote.
- Remotely operates electric devices including household appliances with the optional PLC (Power Line Carrier) Kit.
- Controls optional sanitation equipment including traditional chemical or salt chlorination systems.

## Command Center Components

1. Command Center Display
2. Command Center Keypad
3. Relays and Power Subpanel
4. Deadfront
5. Activator Circuit Board

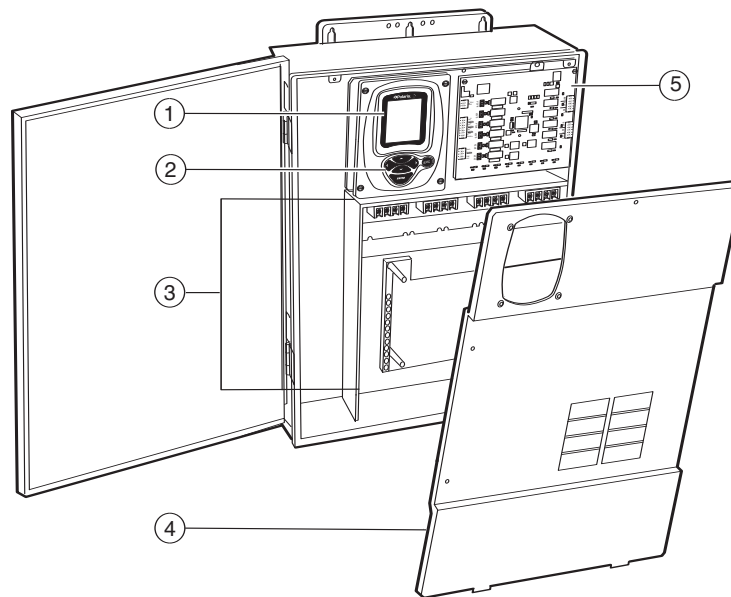



# System Overview

## Starting the Eos Command Center

**To activate:** Turn on circuit breaker (main power source) to power up the unit.





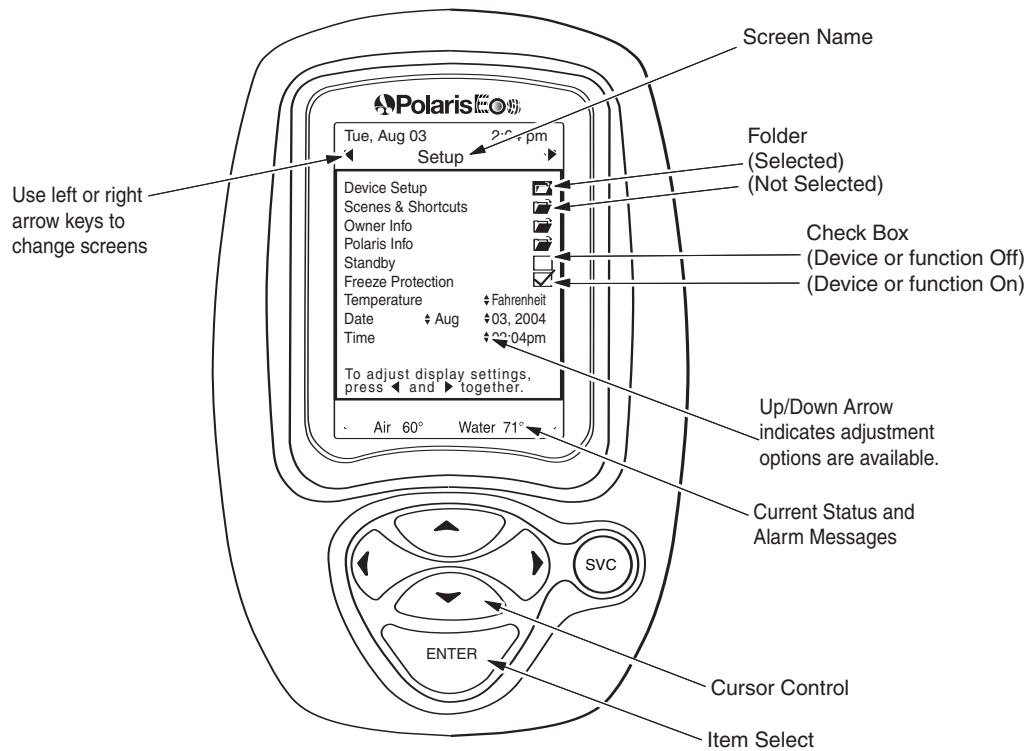

**To disable or put in "Standby Mode":** Press and hold the Enter key for five seconds. Press any key to reactivate.

**To shut down:** Turn off main power source to command center.

## Display Overview



## Display Symbols

-  Folders indicate that additional screens, menu or setup options are available for an item.
-  Check Boxes are used to turn functions or devices on or off. Checked = On.
-  Up/Down Arrow indicates adjustment options are available for the field next to it and the up/down arrow keys are used to select or enter the setting.
-  Item in reverse (white text on black box) indicates cursor is over item or field.
-  Asterisk in front indicates a text field (blank line) that can be named by user.
-  Clock next to equipment status field means device is scheduled to be "on."
-  Flame next to status field of heater means heater is firing.

# Screen Overviews



## Setup Screen

During installation, this screen is used to define and configure the system. Adjustments to this screen will usually be minimal. For a complete description of system setup and the associated screens, refer to the Eos Installation and Operation Guide.

**Device Setup** is used to setup system equipment.

**Scenes & Shortcuts** can be established to start or stop several devices with a single command.

**Owner Info** is used to input of owner name and address.

Serial number and service contact phone numbers can be input in **Polaris Info**.

Checking the **Standby** box disables all automatic control functions.

**Freeze Protection** should always be checked to protect equipment from freezing conditions.

**Temperature** sets Fahrenheit or Celsius.

Sets **Date** by month, day and two-digit year.

Sets **Time** along with an am or pm designation.

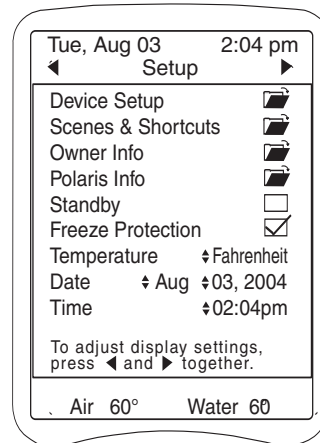

## Optional Device Control Screens

If a Watermatic pH/ORP controller or salt chlorinator is installed, additional control screens become available.

## Main Screen

Once setup is complete, the Main screen provides access to most commonly needed measurements and functions. Most routine maintenance and adjustments can be made from this screen.

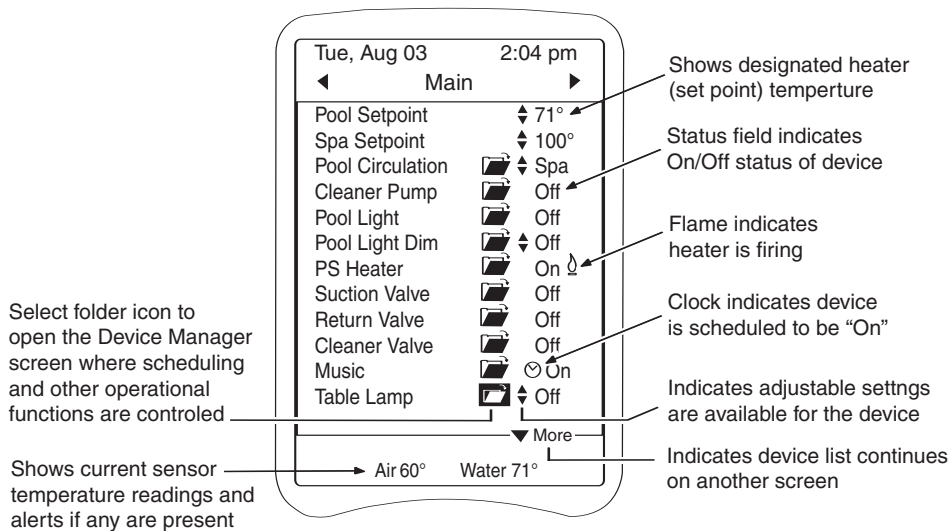



## Device Manager Screens

Each piece of equipment controlled by Eos has a manager screen with specific settings for the device.

From these screens equipment can be:

- Turned on or off
- Set for specific on or off durations
- Scheduled to be active at specific times on specific days

The screenshot shows the 'PS Heater Manager' screen. At the top, it displays 'Tue, Aug 03' and '2:04 pm'. Below that is a back arrow and 'PS Heater Manager'. The main content area is titled 'PS Heater' and 'Off'. Underneath is 'Manual Control' with 'Duration' and 'Remaining' fields. 'Duration' is set to '04h' and 'Remaining' is '00h 00m'. Below that is a 'Schedules' section with a table:

Day	Start	Stop
off	12:00p	12:00p
off	12:00p	12:00p
off	12:00p	12:00p
off	12:00p	12:00p

Below the table are 'Range' (set to 0°), 'Heater Cool Down' (checked), and 'Freeze Protect' (unchecked). At the bottom, it shows 'Air 60°' and 'Water 71°'.

## Navigating the System

- Use the keypad arrow (cursor control) keys to move through the screens and menu options.
- When the cursor is over an item, it will appear darkened or in reverse (white on black instead of black on white).
- Press the Enter key to select an item, open a folder, or activate/deactivate a feature with a check box.

### To set or adjust an item:

1. Use the keypad arrow keys to move the cursor over the item.
2. Press <Enter> to select the item. The item will flash.
3. Use the up/down keys to choose or enter the setting.
4. Press <Enter> to activate the setting.

### Using text fields

1. Move cursor over the text field and press <Enter> to select.
2. Use the up/down arrow keys to move through the alpha-numeric options.
3. Use the right arrow key to move to the next position within the field.
4. Press <Enter> when the entry is complete.

### Using nameable text fields

1. Move cursor over name field and press <Enter> to select. The last letter of the name will blink.
2. Use the left arrow key to erase the item name.
3. Use the up/down arrow keys to access the alpha-numeric options.
4. Use the right arrow key to move to the next position within the field.
5. Press <Enter> when the entry is complete.

To change the item back to "None," move to the asterisk and press <Enter>.

# Using the Eos System



To adjust the brightness or contrast of the display, press the left and right arrow keys simultaneously to open the **Command Center Setup Screen**.

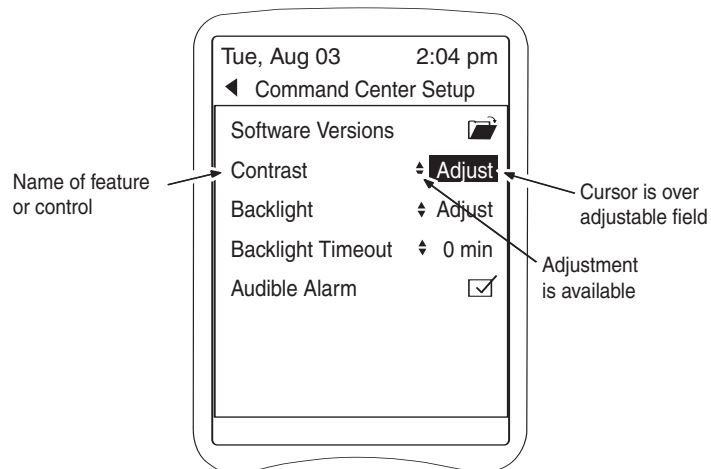

**Software Version** provides access to information on the current software versions for the command center and the various devices it controls.

**Contrast** controls readability of text, light or dark, on screen.

**Backlight** controls the illumination of screen.

**Backlight Timeout** sets a time limit for inactivity after which the light on the display turns off. Hit any key to reactivate the display.

When checked, **Audible Alarm** enables the alarm within the Command Center that sounds when an alert condition exists. (If remote devices are used to control the Eos, the alarm for each device can be enabled or disabled independently.)

To set or adjust any of the display controls:

1. Use arrow keys to move the cursor over the field to be adjusted. (Ex: **Adjust** )
2. Press <Enter> to select the item. The item will flash.
3. Use up arrow to increase or down arrow to decrease screen effect until it is at desired setting.
4. Press <Enter> to activate setting.

Press the left arrow key to return to the **Main** screen.



## Common Tasks

### Changing the Heater (Setpoint) Temperature Setting

On the **Main** screen:

1. Move the cursor to the Up/Down Arrow symbol next to the pool or spa (setpoint) temperature setting.
2. Press <Enter> to select the item.
3. Push the up or down arrow key to change the temperature setting.

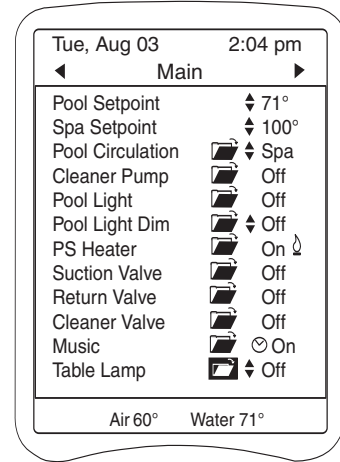

### Turning Equipment On or Off

On the **Main** screen or **Device Manager** screen:

1. Move the cursor to the Status field next to the device.
2. Press <Enter> to change the status, turn it on or off.

### Customizing the Main Screen Display

Items can be reordered or devices grouped to make the system easier to work with.

To move an item up or down on the menu:

1. Move the cursor to the Status field of the particular device.
2. Press and hold <Enter>.
3. Push the up or down arrow key to move the device.

To insert a space between menu items:

1. Move the cursor to the Status field of the device you want to insert a line above.
2. Press and hold <Enter>.
3. Press the up and down arrow keys simultaneously. A space will be inserted above the item.

To delete the space, move the item back up.

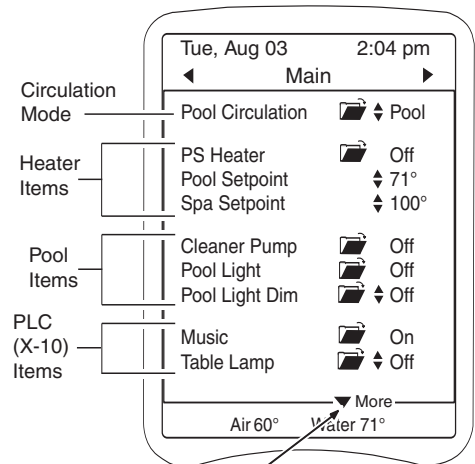

Indicates device list continues on another screen

## Setting the Time and Date

It is imperative that the date and time are set correctly to ensure proper function of the equipment scheduling features.

The command center offers multiple start and stop times and the ability to set various schedules. The built-in 365 day calendar clock accommodates multiple schedules without monthly reprogramming.

Adjustments are made on the **Setup** screen.

To set or adjust the date:

1. Use the arrow keys to move the cursor over the month field.  
(Ex: **Aug**)
2. Press <Enter> to select the item. The item will flash.
3. Use the up or down arrows to select the desired setting.
4. Press <Enter> to activate the setting.
5. Use the same steps to set the day and year.

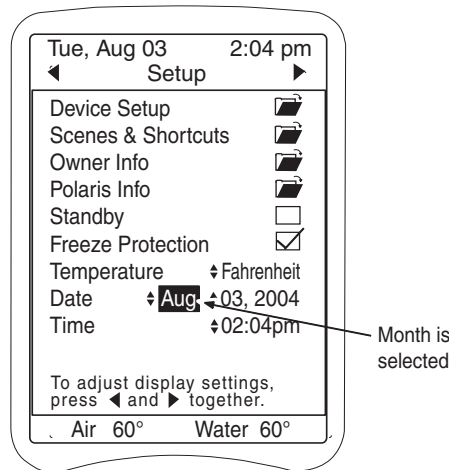

To set or adjust the time:

1. Use the arrow keys to move the cursor over the hour field  
(Ex: **02**) first.
2. Press <Enter> to select the item. The item will flash.
3. Use the up arrow to run through the setting options, selecting the appropriate hour with am or pm.
4. Press <Enter> to activate the setting.
5. Use the same steps to set the minutes.

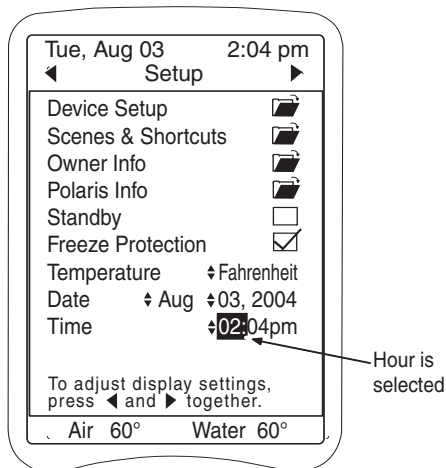

When adjustments are complete, use the left or right arrow key to return to the **Main** screen.





## Setting the Circulation Mode

The options available for the circulation pump are dependent on the type of pool, the equipment installed, and the settings chosen at installation.

Pool Configuration	Circulation Mode Options	Additional Settings With a Two-Speed Pump
Pool/Spa with Shared Pump and Spillover Enabled	Pool, Spa, Spill, Off	Pool LS, Spa LS, Spill LS
Pool/Spa with Shared Pump without Spillover	Pool, Spa, Off	Pool LS, Spa LS
Pool Only	On, Off	On, Low, Off
Spa Only	On, Off	On, Low, Off
Pool/Spa with Separate Pumps		
Pool Circulation	On, Off	On, Low, Off
Spa Circulation	On, Off	On, Low, Off

To set (manually activate) the circulation mode:

1. Move the cursor over the **Status** field (Ex: **Off**) and press <Enter> to select the item. The item will flash.
2. Use the up/down arrow keys to access the circulation mode options.
3. Select the desired mode and press <Enter> to activate the selection.

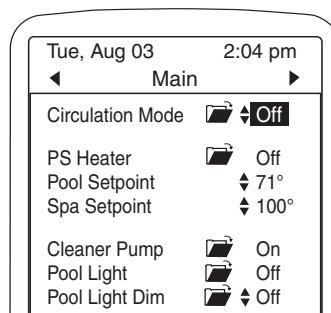

When a circulation mode is entered, either manually or as a scheduled event, circulation pumps as well as the appropriate valve actuators will activate.

When set manually, the selected mode will run for as long as the Manual Duration (found on device manager screen) specifies, if no other schedules are set.

To schedule the circulation mode:

Move the cursor over the circulation folder and press <Enter> to open the **Device Manager** screen.

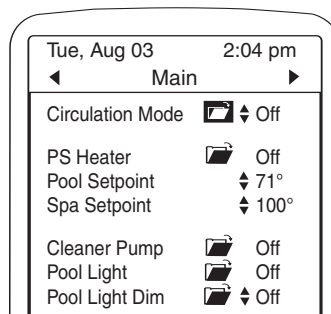



## Setting Manual Controls and Scheduling

Each piece of equipment has a manager screen (accessed by selecting the folder next to the item on the **Main** screen) with specific settings for the device. All manager screens include:

### Status

Indicates on/off status for most devices. For a pool/spa circulation pump it also indicates the current circulation mode (pool, spa, or spillover).

### Manual Control

Specifies how long a device will be active when turned on manually.

Some equipment is dependent on other equipment to operate properly. The rules governing these dependencies are referred to as Device Manager Rules. Manually activated devices are subject to these rules, meaning that even though a device turned is “on,” it may not activate unless all the rules are met. See **Device Associations, Safety Delays and Lockouts** for further information.

Each device has a **Duration** default. When the specified duration is complete, the device control returns to the established schedules.

**Remaining** refers to how much longer the device will be active under manual control.

### Schedules

Scheduling is available for each device. Up to four schedules can be set based on date and time. When scheduling, equipment associations and manager rules should again be taken into consideration. For detailed information on equipment, review the original manufacturer’s documentation or talk with a pool professional.

**Day:** Specifies day(s) of operation  
(Sun, Mon, Tue, etc. or All)  
(M-F = Monday thru Friday)  
(S-S = Saturday and Sunday)  
(MWF = Mon., Wed. and Friday)

**Start:** Specifies start time

**Stop:** Specifies stop time

**Mode:** For circulation pump only: specifies circulation mode (pool, spa, spillover)

Schedule **priority is based on the order of the schedules** from the top (highest priority) to the bottom of the menu.

When a device is scheduled and active, a clock symbol will display next to it.

### Freeze Protect

Enables or disables freeze protection for the specific device. **Freeze Protect must be specified for each device individually. Freeze Protection on the Setup screen must also be checked.**

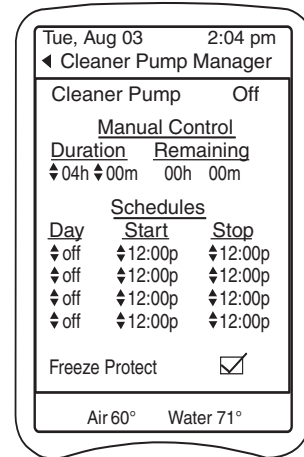



## Circulation (Circ) Pump Manager

The same circulation options available on the **Main** screen are available on the manager screens by selecting and adjusting the **Status** field.

When manually activated, the chosen mode will run as long as the **Duration** specifies.

To change Duration:

1. Move the cursor over the hours (Ex: **03**) and press <Enter> to select. The item will flash.
2. Use the up/down arrow keys to select time.
3. Press <Enter> to activate the selection.
4. Use right arrow to move to minutes and set if desired.

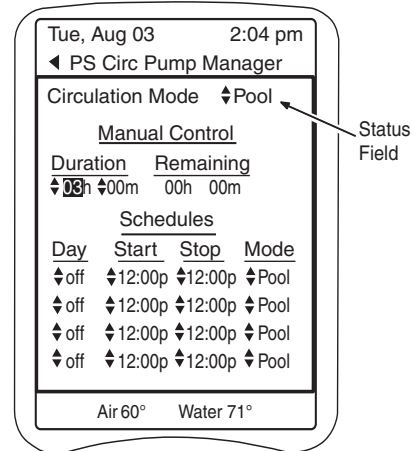

Schedules can be set for different circulation modes. **Schedule priority is based on the order of the schedules**, from the top (highest priority) to the bottom of the menu. **Start** and **Stop** time is set in hours and minutes with am / pm designated by the hour.

To schedule circulation **Mode**:

1. Use the arrow keys to move the cursor over the status field under Day (Ex: **off**) and press <Enter> to select. The item will flash.
2. Use the up/down arrow keys to set the day. Press <Enter> to activate the selection.
3. Move cursor to Start hour field and press <Enter> to select.

Use the up/down arrow keys to choose start time. Press <Enter> to activate. Set minutes if desired.

4. Move cursor to Stop. Set stop time, hours and minutes.
5. Move cursor to Mode, select the circulation mode and press <Enter> to activate.
6. Use the left arrow key to return to the **Main** screen.

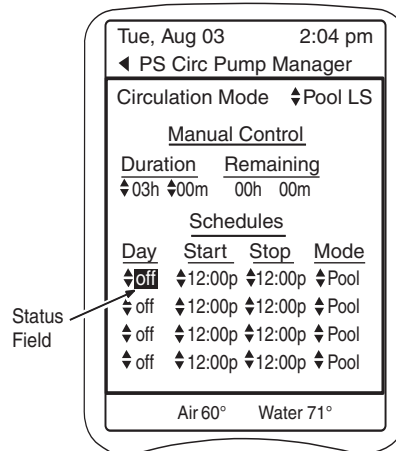



## Using Manager Screens

Access any manager screen from the **Main** screen by selecting the folder next to the item.

### Heater Manager

An adjustable high and low operating **Range** is available for heaters. Defaults are 0° and 104° F.

Range can be used to set multiple heaters to heat to different temperatures. For example: two heaters can be set to heat together up to a certain temperature, such as 95° F, with only the second continuing to heat to the maximum.

**Heater Cool Down** is a safety feature that provides a two-minute delay in turning off the circulation pump after the heater has completed its firing cycle. This allows the heater to cool down.

If **Freeze Protect** is disabled (unchecked), the heater will not fire during “Freeze Alert.” If enabled, the heater will fire if the water temperature drops to 34° F or the air temperature drops to 36° F.

Tue, Aug 03 2:04 pm  
 ◀ PS Heater Manager

PS Heater Off

Manual Control

Duration Remaining  
 ⚡04h ⚡00m 00h 00m

Schedules

Day	Start	Stop
⚡off	⚡12:00p	⚡12:00p
⚡off	⚡12:00p	⚡12:00p
⚡off	⚡12:00p	⚡12:00p
⚡off	⚡12:00p	⚡12:00p

Range ⚡0° ⚡104°

Heater Cool Down

Freeze Protect

Air 60° Water 71°

### Spa Dep Valve Manager

If a Spa Dependent Valve is installed on the pool, use **Spa Mode Position** to set the valve position, open or closed, when the system is in circulation mode “Spa.”

1. Use the arrow keys to move the cursor over the Spa Mode Position field. (Ex: **Off**)
2. Press <Enter> to select On or Off.

Tue, Aug 03 2:04 pm  
 ◀ Spa Dep Valve Manager

Spa Dep Valve Off

Manual Control

Duration Remaining  
 ⚡04h ⚡00m 00h 00m

Schedules

Day	Start	Stop
⚡off	⚡12:00p	⚡12:00p
⚡off	⚡12:00p	⚡12:00p
⚡off	⚡12:00p	⚡12:00p
⚡off	⚡12:00p	⚡12:00p

Spa Mode Position **Off**

Freeze Protect

Air 60° Water 71°

### Solar Valve Manager

**Solar Priority**, available on the Solar Valve Manager and Solar Pump Manager screens, sets solar heating to have priority over all other heaters.

When checked (default), the solar heater has priority over other heaters until the water temperature gets within 5 degrees of the Solar Panel Temp. Then, solar heating will shut off and the other heater(s), if activated, will continue to heat until the setpoint is reached.

**Solar Panel Temp** displays the current reading from the temperature sensor on the solar panel.

Tue, Aug 03 2:04 pm  
 ◀ Solar Valve Manager

Solar Valve Off

Manual Control

Duration Remaining  
 ⚡04h ⚡00m 00h 00m

Schedules

Day	Start	Stop
⚡off	⚡12:00p	⚡12:00p
⚡off	⚡12:00p	⚡12:00p
⚡off	⚡12:00p	⚡12:00p
⚡off	⚡12:00p	⚡12:00p

Solar Priority

Freeze Protect

Solar Panel Temp 60°

Air 60° Water 71°



## Setting Scenes and Shortcuts

Scenes and Shortcuts establish one touch control of multiple devices. They can control groups of equipment routinely used together. For example: a Shortcut can turn on the pool light, porch light and landscape lighting. Or they can be used to create a particular mood for entertaining or relaxing.

### Scenes

A Scene is a “snapshot” of the entire system operation that can be recalled to play at any time.

Scenes can be scheduled to run at specific times or activated manually.

Up to five Scenes can be set up, but only one Scene can be played at a time. If a Scene is “in play” and another is recalled (either manually or by a schedule), the latter Scene takes priority.

To set a Scene:

1. Turn on any equipment that you want to operate during the Scene. Setpoints can be part of the Scene.

On the **Main** screen, move the cursor to the Status field of the each device and press <Enter> to select the setting.

In this example: circulation mode is Spa, Spa setpoint is 103°, Pool Light is On, Spa Light is dimmed to 60%, and Music is On.

2. Use the left arrow key to move to the **Setup** screen.
3. Move cursor to the Scenes & Shortcuts folder. Press <Enter> to open the **Scenes & Shortcuts** screen.
4. Move the cursor to the first available text field under My Scenes.
5. Press <Enter> to select the field and use the arrow keys to name the Scene.  
(Ex: **Spa Night**)
6. Move the cursor to the folder next to the newly named Scene and press <Enter> to open the **My Scene Manager** screen.

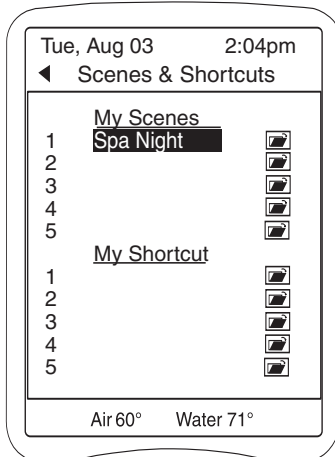
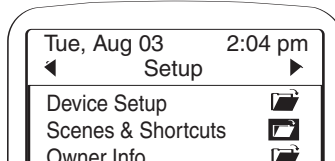
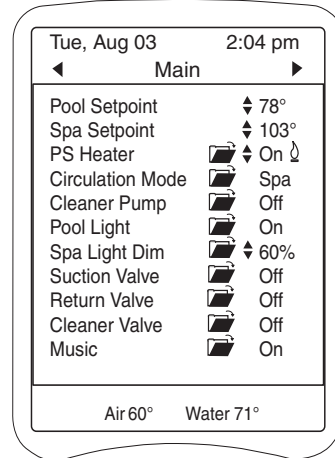



7. Move the cursor to Save and press <Enter> to capture the Scene.

The Scene “Spa Night” is now saved.

It can be manually activated or scheduled just like any other device.

Use the left arrow key to return to the **Main** screen.



8. The Scene is now displayed, just like a device, and can be recalled (activated) at any time by changing the Status to On.

The device manager for the Scene can be accessed by selecting the folder next to it.

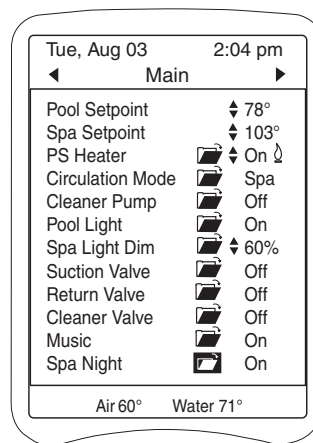

## Shortcuts

Shortcuts are also “snapshots” of system operation. Unlike Scenes that turn devices on or off to set the scene, **Shortcuts are only able to turn devices on.**

Up to five Shortcuts can be set up and run simultaneously.

Shortcuts can run within a Scene, but Scenes cannot run within a Shortcut.

To set a Shortcut:

1. Turn on any equipment that you want to operate during the Shortcut.

On the **Main** screen, move the cursor to the Status field of each device and press <Enter> to select the setting.

In this example: Pool Light is On, Spa Light is dimmed to 60%, Porch Light is On, and LS (Landscape) Lighting is On.

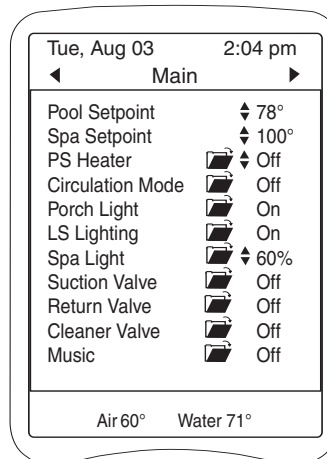



2. On the **Setup** screen, move the cursor to the Scenes & Shortcuts folder. Press <Enter> to open the **Scenes & Shortcuts** screen.

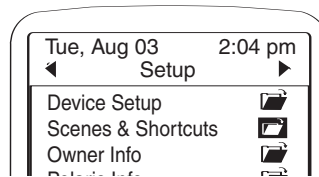

3. Move the cursor to the first available text field under My Shortcuts.

4. Press <Enter> to select the field and use the arrow keys to name the Shortcut. (Ex: **Night Lights** )

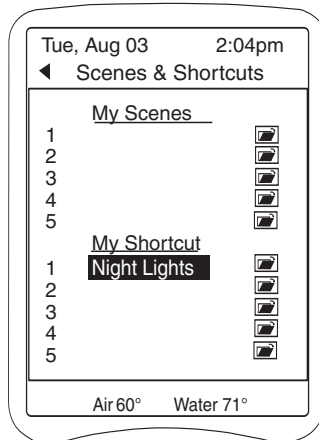

5. Move the cursor to the folder next to the newly named Shortcut. Press <Enter> to open the **My Shortcut Manager** screen.

6. Move the cursor to **Save** and press <Enter> to capture the Shortcut.

The Shortcut “Night Lights” is now saved.

It can be manually activated or scheduled just like any other device.

Use the left arrow key to return to the **Main** screen.



7. The Shortcut is now displayed, just like a device, and can be recalled (activated ) at any time by changing the Status to On.

The device manager for the Shortcut can be accessed by selecting the folder next to it.

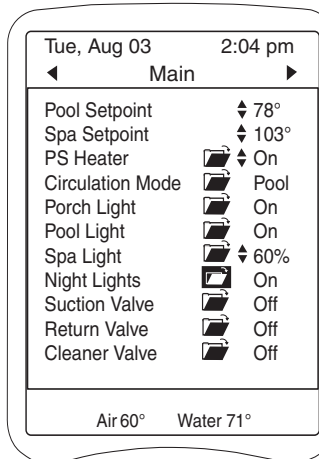

# Understanding Eos System Functions



## Freeze Protection

Freeze protection is activated when the air temperature drops to 36° F or the water temperature drops to 34° F. Manual activation or scheduled operation of Spa Mode will override freeze protection.

During freeze protection, “Freeze Alert” will flash on the bottom of the display screen.

The **Freeze Protection** check box on the **Setup** screen should always be checked (enabled) to protect equipment from freeze damage. The circulation pump is covered by freeze protection as long as this check box is checked.

For all other equipment, **Freeze Protect** must also be specified on the individual device manager screen. Some devices default to freeze protect.

By default, heater freeze protect is unchecked; the heater will not fire during a freeze alert. If freeze protection is checked, the heater will fire when the water temperature drops to 33° F.

During Freeze Alert:

- In the pool/spa combo and pool/spa separate configurations, the system will alternate between activating the spa and the pool equipment every 15 minutes.
- In spa only and pool only configurations, the equipment will alternate for 15 minutes on and 15 minutes off.
- Blowers will run for five minutes every half hour.
- No lighting (pool, spa, landscape, etc.) will activate.

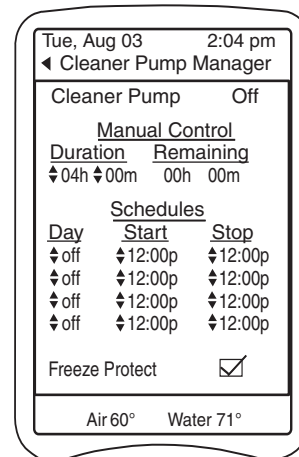
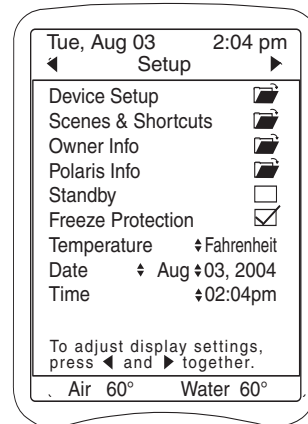



## Alerts and Alarms

The following alert conditions will sound the audible alarm in addition to flashing the alert message at the bottom of the display screen.

### Alert

Pool High Temperature  
Pool Low Temperature  
Spa High Temperature  
Spa Low Temperature  
Wireless Remote Battery Low  
WM#1 High PH Alert  
WM#1 Low PH Alert  
WM#1 High ORP Alert  
WM#1 Low ORP Alert  
WM#1 PH Overfeed  
WM#1 ORP Overfeed  
WM#1 Feeder Empty

### Alert

WM#2 High PH Alert  
WM#2 Low PH Alert  
WM#2 High ORP Alert  
WM#2 Low ORP Alert  
WM#2 PH Overfeed  
WM#2 ORP Overfeed  
WM#2 Feeder Empty

The following Alerts are flashing messages only.

### Alert

Freeze Alert  
WM#1 No Flow  
WM#1 2 Minute Flow Delay  
WM#1 Clean PH Sensor  
WM#1 Cal PH Sensor  
WM#1 Clean ORP Sensor  
WM#2 No Flow  
WM#2 2 Minute Flow Delay  
WM#2 Clean PH Sensor  
WM#2 Cal PH Sensor  
WM#2 Clean ORP Sensor  
Solar Purge Delay  
Solar Panel Temp Too Low  
Spa Has Reached Set Temp

### Alert

Cleaner Requires Pool Mode  
Standby Mode  
CPC-ACT Comm Failure (Cable/Activator)  
CPC-WM1 Comm Failure (Watermatic)  
CPC-WM2 Comm Failure  
SCB Comm Failure  
X10 Comm Failure  
Valves Turning  
Heater Cooling Down  
91 Check Salt  
92 Chlorinator No Flow  
Check Chlorinator

## Device Associations, Safety Delays and Lockouts

Some equipment is dependent on other equipment for proper operation. The rules that govern these dependencies or associations are referred to as **Device Manager Rules**. Manually activated devices are subject to these rules, meaning that even though a device turned is “on,” it may not activate unless all the rules are met. The device manager rules and other safety functions are listed below.

### Heater

When activated (turned on manually or by a schedule), the heater will only fire (indicated by flame on display) if the circulation pump is on and the temperature setpoint is above the current temperature reading.

There is a 45-second operational delay at initial startup of the heater. Once the heater is active and the desired temperature is reached, the heater will turn off and remain off until the temperature falls two degrees below the setpoint. This prevents the heater from short cycling (i.e., turning on and off in rapid succession).



After the heater shuts down, it enters a 2-minute cool down period. **Heater Cooling Down** will be displayed on the screen. If the filter pump is shut down during the cool down, the pump will remain on until the delay is finished and an hourglass will be displayed next to the pump on the screen.

### **Cleaner Booster Pump**

The pool cleaner will only activate when the system is in the pool mode (i.e., water circulating to the pool) as it requires water circulation to function correctly. **Cleaner Requires Pool Mode** is displayed if cleaner schedule requires circulation mode adjustment.

There is a 1-minute prime delay to ensure the water is flowing to the booster pump. The display will read **Prime Delay** during this delay.

If the filter pump is turned off while the cleaner booster pump is running, the controller will automatically shut down the booster pump. The system recognizes that the booster pump cannot run without the circulation pump.

If the booster pump cleaner is active and spa or spa spillover mode is entered the booster pump will shut down and be locked-out. When the spa or spa spillover mode is cancelled, the booster pump schedule will resume.

### **Spa Drain**

The spa drain can only be activated on the Service screen.

### **Valves**

**Valves Turning** is displayed whenever a valve (pool to spa, spa to spillover, solar, etc.) is signaled to rotate. There is a 15 second delay during which the filter pump is shut off. The pump is reactivated when the valves have stopped turning.

### **Solar Heating Systems**

When solar heating is initiated and there is a booster pump cleaner on the system, the booster pump will shut down and be locked-out for a 2-minute **Solar Purge Delay** to allow water to be purged from the solar collectors. When the delay is complete, the booster pump is reactivated.

### **When equipment is manually activated:**

Existing schedules will be overridden. Remember to shut down the equipment, otherwise, the equipment will continue to run until the next scheduled shut down or time-out specified in the device setup.

If spa mode is not turned off, only the water in the spa will be filtered and the pool cleaner will be disabled.

Turning off the filter pump does not reset valves to pool mode. The valves will automatically return to pool mode after 6 hours.

### **Communication Failures**

Communication failure messages (**CPC-ACT Comm Failure**, **X10 Comm Failure**, etc.) are displayed when there is a communications failure between the command center and the system components. Check connections or reposition the remote or antenna and try again.



# Using Optional Components



With the basic system in place, optional components such as remote controls, sanitizing controllers, lighting controls, and even home appliance controls can be added at any time to customize the pool or expand the system capabilities.

## Remote Controls

Eos can be controlled remotely by the Eos Wireless Remote or the In-House Panel remote. Limited system control is also available with the Shortcut remote which can be mounted spa-side or as an in-house panel.

Each remote has its own **Setup** screen where display adjustments can be made. To access this screen for either the Wireless or In-house Panel remote, press the left and right arrow keys of the remote keypad simultaneously.

## Wireless Remote

Battery charge level  and signal reception  are indicated at the top of the display screen. **The battery must be charged for at least five hours before the initial use.** To ensure a full charge, always store the remote on the charger when not in use. An animated scrolling battery symbol on the display indicates the battery is charging.

**Software Version** provides access to current system software information.

Remote device settings, including the unique remote channel setting, are listed on the **Network Settings** screen

**Shutdown** turns off the remote. Useful to conserve battery life. Press any key to reactivate.

When checked, **Audible Alarm** enables the alarm in this remote device to signal when an alert condition exists.

If **Spa Temp Notify** is checked, "Spa Has Reached Set Temp" will be displayed when the water temperature in the spa reaches its designated setpoint.

**Access Code** is a security feature available on the remote control devices. When activated, system change capabilities are limited to authorized users.

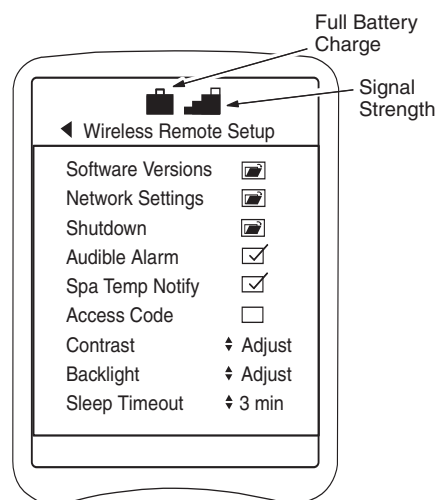



To set an **Access Code**:

1. Check the Access Code box. A new screen will open and request a code.
2. Press any four keys on the keypad, in any order. Press <Enter> to activate the code.
3. Use the left arrow key to exit the **Setup** screen.
4. A confirmation screen will appear. Move cursor to Yes and press <Enter> to activate the change.

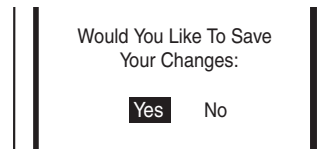
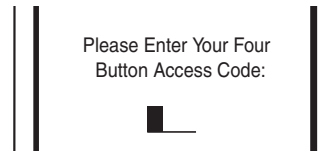

All function selections will lock requiring input of the access code to make changes.

To reset if the code is forgotten:

1. Press the left and right arrow keys simultaneously to open the **Setup** screen.
2. Disable (uncheck) the Access Code box.
3. Press left arrow key to exit the **Setup** screen. Move cursor to Yes on the confirmation screen and press <Enter> to activate the change.

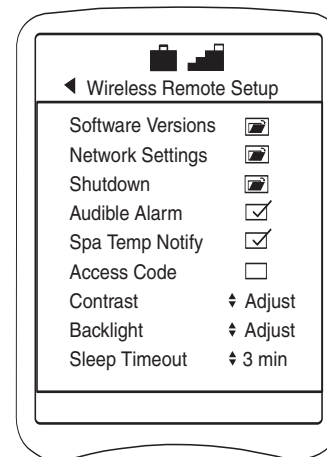

**Contrast** controls readability of text on screen.

**Backlight** controls illumination of display screen.

To conserve battery life, set **Sleep Timeout** to switch the remote to sleep mode after a specified length of time without activity.

To save changes made to any settings on the Wireless Setup screen:

1. Make adjustment, then use the left arrow key to exit the screen. A confirmation screen will open.
2. Move cursor to Yes and press <Enter> to activate the change.



To reset the wireless display if it is locked-up or frozen:

1. Press and hold <Enter>.
2. Press left and right arrow keys simultaneously.



The antenna for the Wireless Remote is positioned to ensure strong, clear communication between the remote and the Eos Command Center from anywhere within the coverage area. The coverage area, shown here in gray, spreads out in a circle from the antenna location.

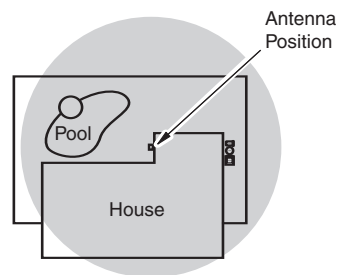

For optimum performance, the remote should be used within line-of-sight of the antenna and away from areas where obstructions might interfere with the radio signal.

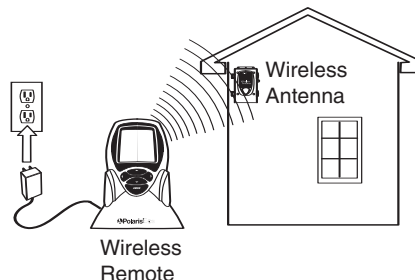

Some objects that can prevent communications are:

- Aluminum siding
- Cyclone fences
- Wrought iron
- Steel framing
- Leaded glass
- Mylar protected windows and doors
- Stone walls and structures
- Gas filled windows and doors
- Microwave ovens
- Other 5.6 GHz frequency devices

## In-House Panel (Wired) Remote

To access the **Setup** screen, press the left and right arrow keys of the remote keypad simultaneously.

**Software Version** specifies the active software version.

**Contrast** controls readability of text on the screen.

**Backlight** controls illumination of screen.

Use **Backlight Timeout** to set a time limit for inactivity after which the display turns off. Hit any key to reactivate the display.

When **Audible Alarm** is checked, the alarm in this remote device signals when an alert condition exists.

**Access Code** is a security feature available on the remote control devices. When enabled, system change capabilities are limited to authorized users.

If two In-House Panels are installed on a system, the **Remote Channel** on the second remote must be adjusted to a different channel to allow simultaneous use.

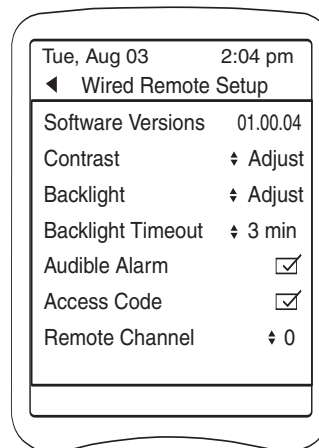

To set an **Access Code**:

1. Enable (check) the Access Code box. A new screen will open and request a code.
2. Press any four keys on the keypad, in any order. Press <Enter> to activate the code.

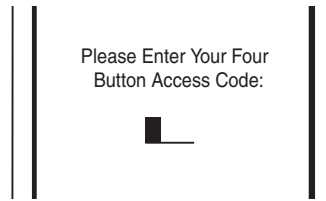

All function selections will lock requiring input of the access code to make changes.

To reset if the code is forgotten:

1. Press the left and right arrow keys simultaneously to open the Setup screen.
2. Disable (uncheck) the Access Code box.

## Shortcut Remote

During installation the control functions of the Shortcut buttons (A, B, C, D) are assigned and the buttons are labeled.

In addition to two factory-set functions, up to eight control functions (4 on Shortcut #1 and 4 on Shortcut #2) can be assigned.

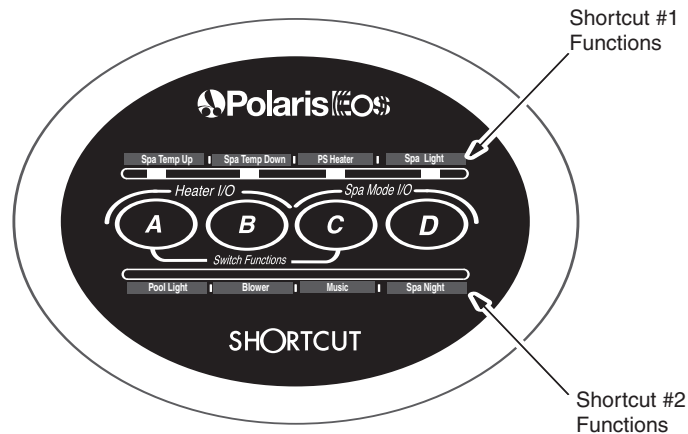

General guidelines for the Shortcut:

- Button LEDs light when their respective device is active.
- If lights (including dimmers) are setup, the remote controls only the on/off function of the device.
- Temperature controls are the default on buttons A and B, if a heater has been set up.
- Temp Up and Temp Down button LEDs light only when the buttons are pushed.
- Temp Up and Temp Down increase or decrease the temperature setpoint by one degree. When the maximum temperature is reached (104 degrees for Spa), the Temp Up button LED will stay lit.

**To switch from Shortcut #1 functions to Shortcut #2 functions**, press buttons A and C simultaneously. The two button LEDs will flash; then the active shortcut button (i.e., C = Shortcut #2) will illuminate. Press A and C again to switch back.

**To activate the heater**, press buttons A and B simultaneously. The two button LEDs will flash together three times. While the heater is firing, the two LEDs will flash every 15 seconds. When the setpoint is reached the flashing will stop.

**To activate Spa Mode**, press buttons C and D simultaneously. All LEDs will flash three times.



## PLC (X-10) Devices

If a PLC (Power Line Carrier) Kit is installed on the system, Eos can control lights, fans, stereos, and other household appliances.

Devices plug into a small receiver that plugs into a regular wall outlet inside the house. The receiver communicates with a transmitter connected to the Eos Command Center.

Once set up, devices can be turned on or off from the **Main** screen (Ex: Music is On) just like any other device wired directly to the Eos. Lamp dimmer modules also provide a percentage setting for bright to dim lighting.

Select the folder next to the PLC device to open the **PLC Device Manager** screen. PLC devices can be scheduled like any other piece of equipment.

Receiver modules can be added to the system at any time. Contact your Polaris dealer for information on PLC Receivers.

To add a PLC device:

1. Scroll to the **Setup** screen on the command center or remote display.

Move the cursor to the Device Setup folder and press <Enter> to open the **Device Setup** screen.

With the cursor over the X-10 Devices folder, press <Enter> to open the **X-10 Setup** screen.

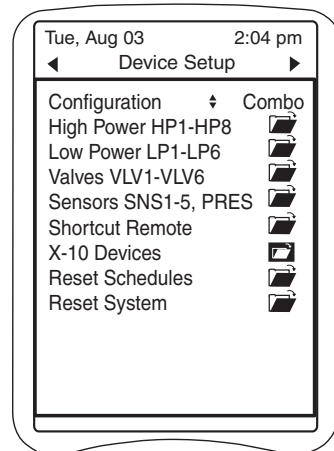
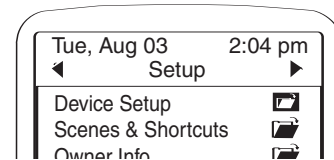
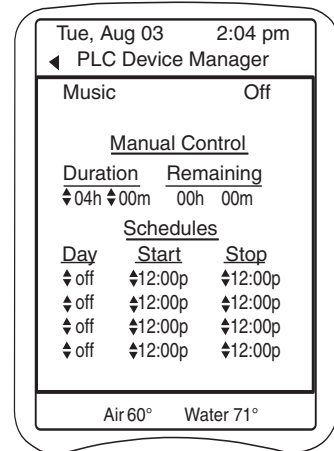
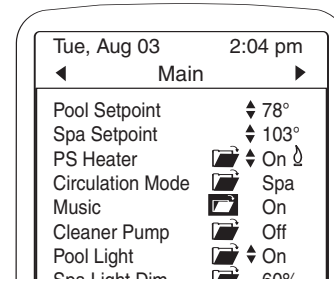

- Review the devices that are already installed to determine the available ID assignments for the new device.

Example: ID for Table Lamp is A01 (A = house code, 01 = device code). A03 is first available code.

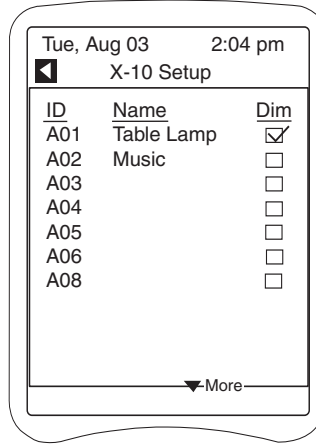

- Plug the receiver module into any wall plug and the device into the receiver.

- Use the dials on the front of the PLC Receiver to set the house code, A-D, and device code, 1-16. (Ex: A03)

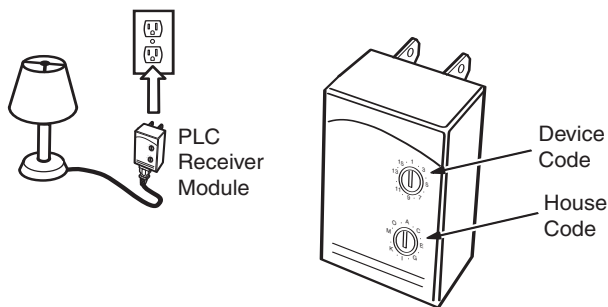

- Move the cursor to the name field next to the code identifier position to be assigned. (Ex: A03)

- Press <Enter> to select the item. A line indicating the text field will appear and the first character position will flash.

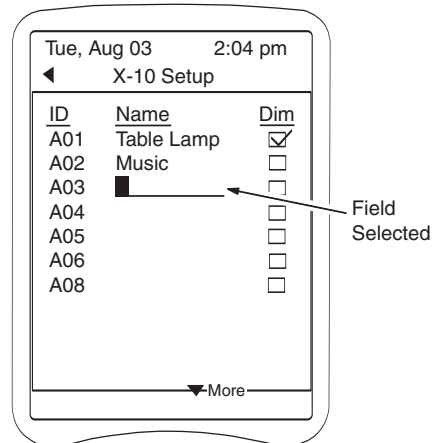

- Enter the device name in the text field using the up/down keys to access the alpha-numeric characters. Press the right arrow key to move to the next letter position within the field. Press <Enter> when naming is complete.

- If a dimmer module is installed, use the right arrow key to move to the dimmer (Dim) check box and press <Enter> to enable (check) dimming control for the device.

The dimmer control provides various settings between 0-100% to produce low to bright light levels.



## Optional Controllers

### Polaris Watermatic C2100 ORP/pH Controller

If a Watermatic controller is installed, a separate control screen is provided to monitor readings and access the controller settings. If a second controller is used, a second control screen will become available.

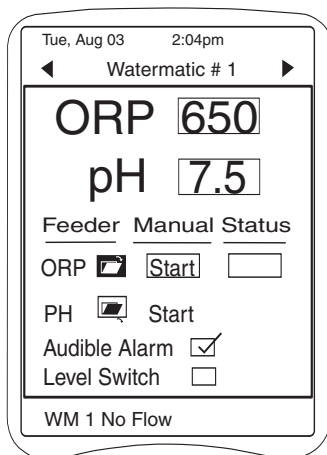

When a controller is installed, an optional nameable field becomes available on the **Setup** screen. If two controllers are installed, there will be nameable fields for each.

To name the controller(s):

1. Move the cursor to the Watermatic #1 text field and press <Enter> to select the field.
2. Enter the name in the text field using the up/down keys to access the alpha-numeric characters and the left/right keys to move within the field.  
(Ex: **Pool**)
3. Press <Enter> when naming is complete.

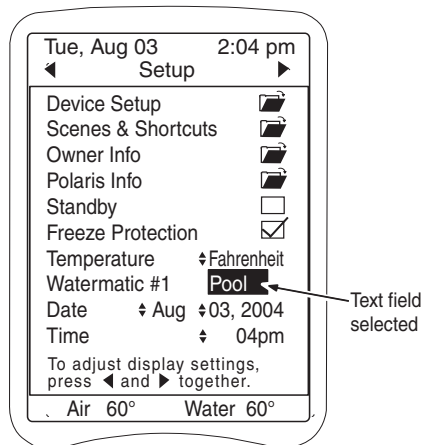

Refer to the Polaris Watermatic C2000/C2100 Owner's Manual for complete operation and maintenance information.



## Salt Chlorinators

If a Polaris AutoClearPLUS or other salt chlorinator is installed, a control screen is provided to monitor salinity levels and access the chlorinator settings. The screen name is designated by the chlorinator installed.

If the AutoClearPLUS is connected to a Watermatic C2100 that is controlled by the Eos system, the Salt Chlorinator screen will not be displayed. Salinity and chlorine production will be monitored and controlled by the Watermatic making this separate control screen unnecessary.

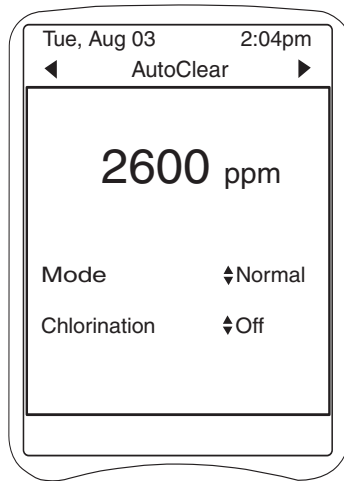

The current salt concentration or **salinity** of the pool is displayed in parts per million (PPM).

**Mode** provides operational options:

Normal – Chlorine production at normal rate.

Super – Produces the maximum amount of chlorine for 24-hours, then reverts back to normal mode. If selected, the pool pump must be activated for a 24-hour run cycle as well.

Service – Disables control while chlorinator is being serviced.

**Chlorination** adjusts the chlorine output from 0 to 100% in increments of 10.

Refer to the Polaris AutoClearPlus Installation and Maintenance Guide or the chlorinator manual for recommended salinity levels, as well as complete operation and maintenance information.



# Troubleshooting

If the Eos system displays the following actions, adjustments may be necessary to restore performance. Contact Polaris Customer Service at 1-800-822-7933 for further assistance, and repair or service information.

**Action: The display screen is blank.**

- Solution:
1. Confirm power is on to the command center.
  2. Press any key to reactivate the display from Backlight Timeout, Shutdown or Sleep Timeout.
  3. Adjust the contrast setting of the display (via Command Center Setup Screen or remote setup screen) if it is too high or too low.

**Action: Wireless remote is not communicating with the command center.**

- Solution:
1. Verify that the remote is charged (and was charged at least 5 hours before the initial use).
  2. Confirm that the remote is within the coverage area of the antenna and the signal is not being interrupted by walls or other structures.
  3. Check the command center's software settings.  
From the Command Center Setup screen, open **Software Versions** and verify that "Telnet" is listed. If not, make sure that the antenna wiring connections are secure and undamaged.
  4. Check the remote's network settings.  
From the Wireless Remote Setup screen, select **Network Settings**. Verify that the Eos SSID number

is the antenna serial number (located on left side of the antenna) with three leading zeros, and the second row of the Key number is the serial number with four leading zeros.

If two remotes are used with the antenna, verify that each remote has its own unique **Remote Address**. (Ex: first remote is set to 101 and second is set to 102)

**Action: The heater does not fire when activated.**

- Solution:
1. Confirm that heater is not in the 45-second startup delay.
  2. Confirm that the circulation pump is running and the temperature setpoint is above the current temperature reading.
  3. If the pool is a pool/spa combination sharing one heater (Combo configuration), verify that the temperature sensor is assigned as "PS Sensor," the heater is assigned as "PS Heater," and the circulation pump is assigned as "PS Circ Pump."
  4. Check the **Range** settings (found on heater manager screen) of the heater. The upper range should be set above and the lower range below the actual water temperature.

**Action: Device (heater, pump, etc.) or feature comes on when activated but immediately turns off.**

- Solution:
1. Verify that the **Duration** setting on the device manager screen has not been incorrectly set to zero.

## **Eos Automated Control System Limited Warranty**

This limited warranty is extended to the original consumer purchaser of this Polaris Eos Control System (the "System") manufactured by Polaris Pool Systems, Inc. ("Polaris"), 2620 Commerce Way, Vista, California 92081-8438, U.S.A.

Polaris warrants the System, including all parts and components thereof, to be free of defects in material and workmanship. This limited warranty applies only to Systems which have been installed and maintained in strict accordance with the installation and operating instructions provided by Polaris, for its intended use with personal or single-family pools (commercial use is excluded), using installation hardware supplied and/or recommended in writing by Polaris, and to Systems which have been connected to the correct voltage supply. The instruction manual should be read in its entirety before the installation of the Polaris Eos Control System. Failure to follow the installation instructions may void this warranty. If you have any questions regarding this Polaris Eos Control System, please call or write us. Be sure to have the serial number of the unit available.

The Polaris Eos Control System is warranted for parts and labor for a period of one year from the date of manufacture of the unit as established by the serial number, or one year from the date of purchase of the Polaris Eos Control System with proof of purchase, whichever is later. This limited warranty does not apply if the failure is caused or contributed to by improper installation, handling, set up adjustments, usage, operation, storage, or maintenance. This limited warranty does not apply if the failure is caused or contributed to by a connection to improper voltage supply, power failure or reduction, signal interference problems, unsuitable application of the System, lack of reasonable and necessary maintenance, damage in transit or during installation, or damage from repairs/alterations/removal made or attempted by anyone other than Polaris or one of its Authorized Service Centers. This limited warranty does not cover cosmetic damage or damage due to acts of God, water, wind, rain, lightning, freezing, rodents or insects, accident, misuse, abuse, negligence, or modification of or to any part of the Polaris Eos Control System. This warranty does not cover consumables such as fuses or batteries. These are normal replacement items.

Polaris will repair or replace, at its option, the System or part or component thereof proven to be defective within the warranty period and under the conditions of the warranty. To make a claim under this warranty, the consumer must contact the Customer Service Department at 1-800-822-7933 (USA and Canada) or (760) 599-9600 with the serial number and proof of purchase. REPAIR OR REPLACEMENT AS PROVIDED UNDER THIS LIMITED WARRANTY IS THE EXCLUSIVE REMEDY OF THE CONSUMER. THIS LIMITED WARRANTY IS IN LIEU OF ALL OTHER WARRANTIES, EXPRESS OR IMPLIED, INCLUDING THE IMPLIED WARRANTIES OF MERCHANTABILITY AND FITNESS FOR A PARTICULAR PURPOSE AND ALL SUCH OTHER WARRANTIES ARE DISCLAIMED EXCEPT TO THE EXTENT ANY IMPLIED WARRANTY MAY BE IMPOSED BY STATE CONSUMER LAW. ANY SUCH IMPLIED WARRANTY IMPOSED BY STATE CONSUMER LAW IS LIMITED IN DURATION TO ONE (1) YEAR FROM THE DATE OF PURCHASE. IN NO EVENT SHALL POLARIS BE LIABLE FOR INCIDENTAL OR CONSEQUENTIAL DAMAGES OF ANY NATURE OR KIND OR FOR DAMAGES TO PERSONS OR PROPERTY, INCLUDING ANY DAMAGES RESULTING FROM THE FAILURE OF OR DEFECT IN ANY EQUIPMENT USED IN CONJUNCTION WITH THE POLARIS EOS CONTROL SYSTEM (E.G., PUMPS, FILTERS, BLOWERS, HEATERS, POOL CLEANERS, LIGHTING, WATER FEATURES, VALVES) OR IN USE WITH A SUBSTANDARD POOL CIRCULATION SYSTEM. THE ONLY REMEDY PROVIDED TO YOU UNDER AN APPLICABLE IMPLIED WARRANTY AND THE LIMITED WARRANTY SET FORTH ABOVE SHALL BE THE REMEDIES EXPRESSLY PROVIDED FOR UNDER THIS LIMITED WARRANTY.

This limited warranty gives you specific legal rights. You may also have other rights that may vary from state to state. Some states do not allow limitation on how long an implied warranty lasts, or the exclusion or limitation of incidental or consequential damages, so the above limitations may not apply to you.

This limited warranty is valid only in the United States of America and Canada, and it does not apply to Polaris Eos Control Systems sold or installed in any other country.

## FCC Statement

This equipment has been tested and complies with the limits for a Class B digital device, pursuant to Part 15 of the FCC rules. These limits are designed to provide reasonable protection against harmful interference in a residential installation. This equipment generates, uses and can radiate radio frequency energy, and if not installed and used in accordance with the instructions, may cause harmful interference to radio communications. However, there is no guarantee that interference will not occur in a particular installation. If this equipment does cause harmful interference to radio and television reception, which can be determined by turning the equipment off and on, the user is encouraged to try to correct the interference by one or more of the following measures:

- Reorient or relocate the receiving antenna.
- Increase the separation between the pool filtration equipment and the receiver.
- Connect the equipment to an outlet on a different circuit from the one to which the receiver is connected.

This equipment has been certified to comply with the limits of a Class B computing device, pursuant to FCC rules. In order to maintain compliance with FCC regulations, shielded cables must be used with this equipment. Operation with non-approved equipment or unshielded cables is likely to result in interference with radio and television reception. The user is cautioned that changes and modifications made to this equipment without the approval of the manufacturer could void the user's authority to operate this equipment.

FCC ID: PFU-E3

This device complies with Part 15 of the FCC rules. Operation is subject to the following conditions:

1. This device may not cause harmful interference.
2. This device must accept any interference received including interference that may cause undesired operation.

This Class B digital apparatus meets all requirements of the Canadian Interference Causing Equipment Regulations.





Your pool. Our reputation.

USA: 2620 Commerce Way, Vista, CA 92081-8438 • 760-599-9600 • 1-800-822-7933

[www.polarispool.com](http://www.polarispool.com)

# INSTALLATION AND OPERATION INSTRUCTIONS



---

Personalized Automated Control System



# Table of Contents



- Important Information
- Introduction .....1
  - Components .....1
  - Command Center Specifications .....2
  - Command Center Features .....3
  - Application Checklist .....4
  - Command Center Accessories .....5
- Installation .....7
  - Plumbing Guidelines .....7
  - Command Center Installation .....10
  - HP (High Power) Devices .....12
  - LP (Low Power) Devices .....14
  - Valves .....16
  - Sensors .....18
  - Solar Sensors .....20
  - Optional Relays .....22
    - Additional HP Relays .....22
    - Dimmer Relay .....22
    - 2-Speed Relay .....24
  - Optional PLC (X-10) Kit .....26
  - Optional Expansion Panel .....28
  - Optional Controllers .....32
    - Polaris Watermatic® C2100 ORP/pH Controller .....32
    - Salt Chlorinators .....34
      - Direct Eos Connection .....34
      - Watermatic C2100 Connection .....36
  - Optional Remote Control .....38
    - RBC Hub Card .....38
    - Wireless Remote Kit .....40
    - In-House Panel (Wired) Remote .....44
    - Shortcut Remote .....46
- System Setup .....48
  - Starting the Eos System .....49
    - Command Center Display Overview .....49
    - Command Center Setup Screen Overview .....50
    - Setup Screen Overview .....51
  - Setting the Date and Time .....52
    - Device Setup Screen Overview .....53
  - Completing Device Setup .....54
    - Device Setup - Configuration Combo .....55
    - Device Setup - Configuration Pool Only .....61



Device Setup - Configuration Spa Only	67
Device Setup - Configuration Separate	73
PLC (X-10) Kit	79
Customizing the Main Screen	80
Circulation Mode (Pool Circulation, Spa Circulation)	81
Manual Control and Scheduling	82
Device Manager Screen Overview	82
Circ Pump Manager	83
Heater Manager	84
Spa Dep Valve Manager	85
Solar Valve Manager	85
Setting Scenes and Shortcuts	86
Scenes	86
Shortcuts	87
Remote Control Setup	89
Wireless Remote Setup Screen	89
In-House Panel Remote Setup Screen	91
Shortcut Remote Setup	93
Optional Controllers	95
Watermatic Controller Control Screen	95
Salt Chlorinator Control Screen	96
System Operation	97
Service Mode	97
Freeze Protection	98
Alerts and Alarms	99
Device Associations	100
Safety Delays and Lockouts	101
Troubleshooting	102

# Important Information



## WARNING: RISK OF ELECTRICAL SHOCK.

- **Read and follow all installation instructions carefully.**
- Electrical work should be performed by a licensed electrician and conform to all national, state and local codes.
- Install all electrical equipment at least 5 feet (1.5 m) from inside wall of pool or spa using nonmetallic plumbing. Canadian installations must be at least 3 meters from the water.
- A ground-fault circuit interrupter (GFCI) must be utilized if this device is used to control underwater light fixtures. The conductor on the load side of the GFCI should not occupy conduits, boxes or enclosures containing other conductors unless the other conductors are also protected by a GFCI. All GFCIs and ground-fault circuit breakers (GFCBs) should be tested daily before pool or spa use. Refer to local codes for complete details.
- A GROUND bar terminal is located on the panelboard in the Command Center. Per National Electrical Code (NEC) Article 250-122, this terminal must be connected to the ground means on the electric service or supply panel with a continuous copper (minimum 8 AWG (8.4 mm<sup>2</sup>) insulated wire.
- Use an insulated or bare copper conductor no smaller than No. 8 AWG (US) or No. 6 AWG (Canada) to connect the local common bonding grid in the area of the pool or spa to the bonding lugs at the bottom right corner of the command center. Bond all field-installed metal components (rails, ladders, drains, etc.) located within 5 feet (1.5 m) of the pool or spa.
- Eos Command Center (Model E3) output circuits evaluated for one level of protection for circuits accessible to tub occupant.
- Polaris relays are Certified/NRTL for both Canada and the US to ensure one level of protection.
- Use only Polaris equipment (or equivalent) for the 24 VAC and 24 VDC external circuits.
- For continued protection against fire, replace transformer fuses (primary and secondary) only with fuses of like type and rating.
- Do not install or service this equipment if precipitation is present or imminent.
- Always keep command center door closed when not performing setup or service.
- Do not allow children to handle this product.

The Eos Wireless Remote requires a fully charged battery at startup. **Charge battery for at least 5 hours before use.** An inadequate charge can permanently damage the battery.





## **FCC Statement**

This equipment has been tested and complies with the limits for a Class B digital device, pursuant to Part 15 of the FCC rules. These limits are designed to provide reasonable protection against harmful interference in a residential installation. This equipment generates, uses and can radiate radio frequency energy, and if not installed and used in accordance with the instructions, may cause harmful interference to radio communications. However, there is no guarantee that interference will not occur in a particular installation. If this equipment does cause harmful interference to radio and television reception, which can be determined by turning the equipment off and on, the user is encouraged to try to correct the interference by one or more of the following measures:

- Reorient or relocate the receiving antenna.
- Increase the separation between the pool filtration equipment and the receiver.
- Connect the equipment to an outlet on a different circuit from the one to which the receiver is connected.

This equipment has been certified to comply with the limits of a Class B computing device, pursuant to FCC rules. In order to maintain compliance with FCC regulations, shielded cables must be used with this equipment. Operation with non-approved equipment or unshielded cables is likely to result in interference with radio and television reception. The user is cautioned that changes and modifications made to this equipment without the approval of the manufacturer could void the user's authority to operate this equipment.

### **FCC ID: PFU-E3**

This device complies with Part 15 of the FCC rules. Operation is subject to the following two conditions:

- This device may not cause harmful interference.
- This device must accept any interference received including interference that may cause undesired operation.

This Class B digital apparatus meets all requirements of the Canadian Interference Causing Equipment Regulations.

# Introduction



Designed to provide easy and convenient control of most pool and spa functions, the Polaris Eos Command Center:

- Controls pool and spa equipment, waterfalls, fountains, and lighting.
- Schedules regular pool and spa routines such as cleaning and circulation.
- Can be programmed to operate multiple devices with the touch of a single button.
- Components, options and functions can be added after installation is complete.
- Can be expanded, interfacing with multiple command centers to provide up to 32 high power relays, 24 low power connections and 24 actuator connections.
- Operates independently or can be remotely controlled from optional in-house wired remotes, wireless remotes or a spa-side remote.
- Can remotely operate electric devices, including household appliances, with the optional PLC (Power Line Carrier) Kit.
- Can control optional sanitation equipment including traditional chemical or salt chlorination systems.

## Command Center Components

1. Command Center
2. Mounting Brackets
3. Temperature Sensor (2)
4. Wiring Identifier Labels
5. High Power Relay (4)  
Circuit breakers, GFCIs and 3-way valves not included.

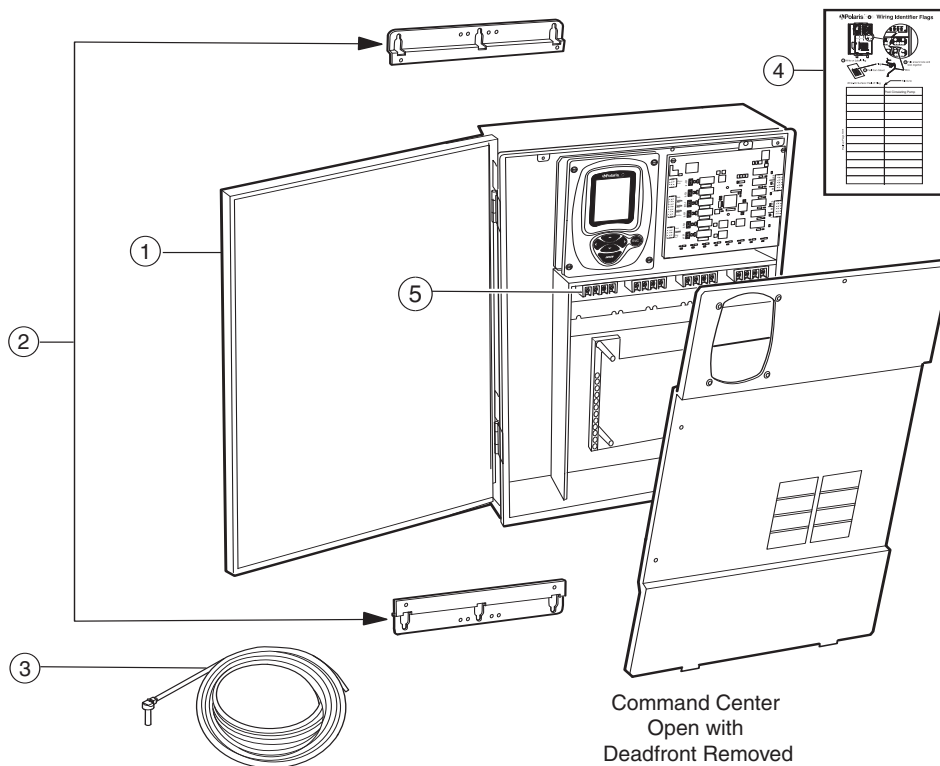



## Command Center Specifications

<b>Dimensions:</b>	22.5" H x 17" W x 4.75" D
<b>Weight:</b>	30 lbs. (without packaging materials)
<b>Input:</b>	115 VAC, 50/60 Hz, 1.5 AMP
<b>Output:</b>	24 AC, 4A
<b>High Power Relays:</b>	4 standard (4 optional on base unit) Contact Rating (High Voltage): 25A; 3 HP at 240VAC, 1.5 HP at 120VAC
<b>Low Power Relays:</b>	6 standard Contact Rating (Low Voltage): 8A at 120VAC isolated
<b>Valve Connections:</b>	6 standard
<b>Sensor Connections:</b>	6 standard
<b>Display:</b>	Graphic, LCD, menu-driven

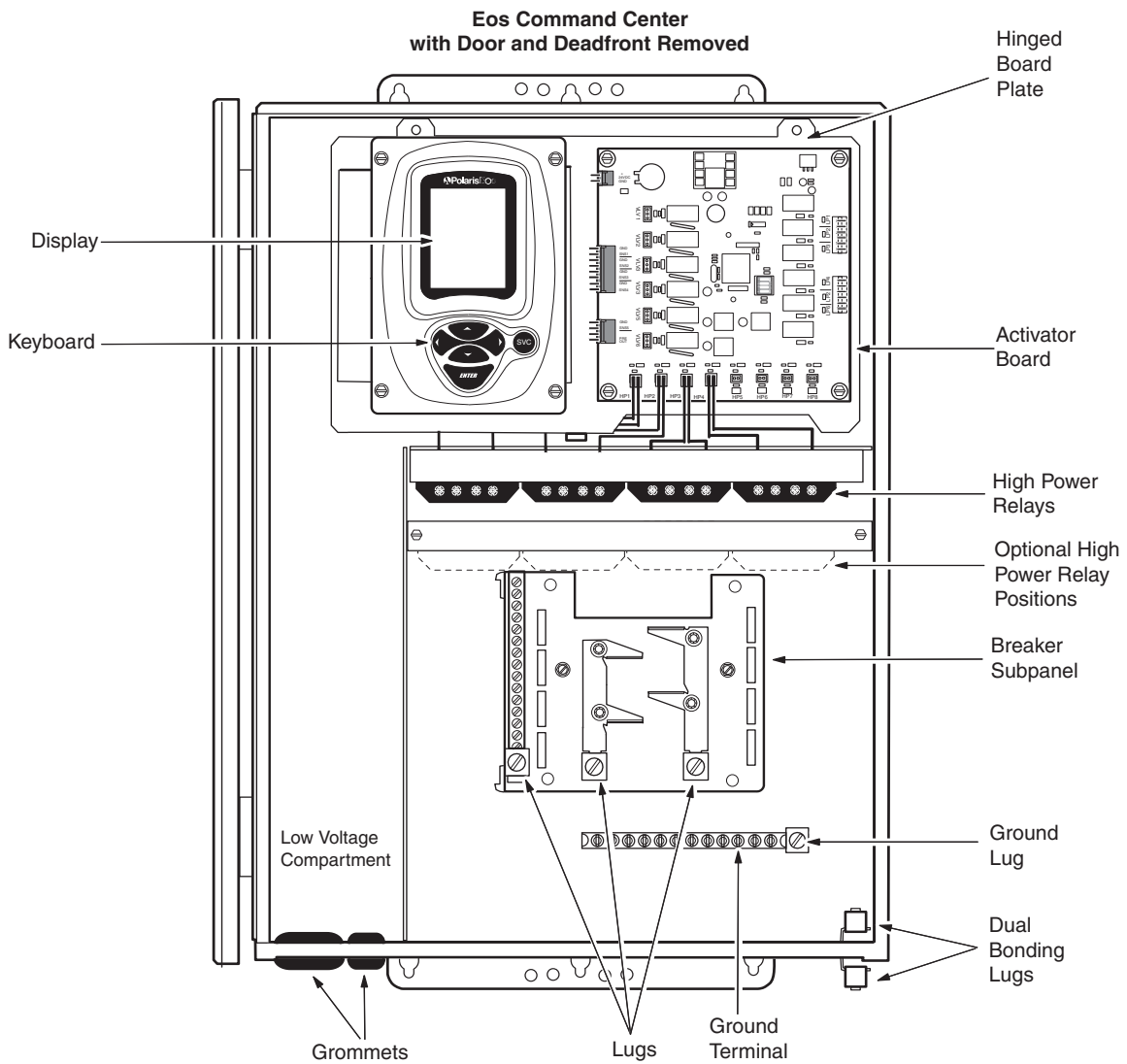

## Command Center Features

The Eos can be utilized with any pool/spa configuration:

- Combo - Pool and Spa combination
- Pool Only - One Pool
- Spa Only - One Spa
- Separate - Pool and spa plumbed separately.
- None - Used for auxiliary equipment such as landscape lighting, etc.



### The Eos controls:

#### Blowers

#### Chemical or Salt Chlorinators

#### Dimmers

#### Heaters

- Pool
- Spa

#### Lighting

- Pool, Spa and Perimeter
- Fiber Optics
- Color Wheel
- Low-voltage Landscape

#### Pool Chillers

#### Pumps

- Pool Circulation
- Pool Heat
- Automatic Pool Cleaner
- Spa Circulation
- Spa Heat
- Spa Jet
- Solar Heat
- Auxiliary (Water Feature, etc.)
- Two Speed (requires 2-speed relay)

#### Power Line Carrier (PLC) Devices

- Signal transmission for X-10 type devices such as household lights, appliances, stereos, etc.

#### Sensors

- Air Temperature
- Water Temperature
- Pressure Sensor

#### Valve Actuators

- Circulation for pool/spa combination
- Spa drain, fill and spillover
- Solar Systems
- Automatic Pool Cleaners
- In-Floor Cleaning Systems
- Water Features

**Any other 120/240V device under 3 HP or 1500 watts.**



## Application Checklist

What will the Eos unit control? Use this checklist to determine the equipment requirements for the application and if additional equipment will be needed.

Equipment	Yes?	Relays Required	Valve Actuators Required
<b>Automatic Valves</b>	<input type="checkbox"/>	-	2 (1 for suction, 1 for return)
Pool/Spa Combination			
Pressure Side Cleaner	<input type="checkbox"/>	-	1
Controlled with Automatic Valve			
Solar	<input type="checkbox"/>	-	1
Using Automatic Valve*			
Water Feature Using	<input type="checkbox"/>	-	1 Each
Automatic Valve			
<b>Controllers</b>			
Polaris Watermatic C2100	<input type="checkbox"/>	0 Use CPC connection	-
ORP/pH Controller			
Polaris AutoClearPLUS	<input type="checkbox"/>	0 Use RS-485 connector	-
Salt Chlorinator			
<b>Heaters</b>			
Heater (Gas or Propane)	<input type="checkbox"/>	0 Use heater connection	-
Heater (Electric)	<input type="checkbox"/>	0 If thermostat is low voltage	-
		1 If thermostat is high voltage	-
<b>High-Voltage Accessories</b>	<input type="checkbox"/>	1 Each	-
<b>Lighting</b>			
Pool Light	<input type="checkbox"/>	1	-
Spa Light	<input type="checkbox"/>	1	-
Dimmer	<input type="checkbox"/>	1 (Dimmer Relay required)	-
Fiber Optic Lighting	<input type="checkbox"/>	1 For on/off control only	-
		2 For on/off plus color wheel control	-
Low-Voltage Accessory	<input type="checkbox"/>	0 Use low-voltage	-
Landscape Lights, etc.		connection	
<b>Pumps</b>			
Cleaner Booster Pump	<input type="checkbox"/>	1	-
Filter Pump – 1 Speed	<input type="checkbox"/>	1	-
Filter Pump – 2 Speed	<input type="checkbox"/>	2 (1 regular, 1 2-speed)	-
Solar	<input type="checkbox"/>	1	-
Using Booster Pump*			
Spa Jet Pump	<input type="checkbox"/>	1	-
Water Feature Using	<input type="checkbox"/>	1 Each	-
Separate Pump			
<b>Spa Blower</b>	<input type="checkbox"/>	1	-
<b>Totals</b>		___ (4 included, 8 max.)	___ (6 max.)

If more relays or valve positions are needed, the Eos Expansion Panel (part #E9) provides 4 additional HP Relays (expandable to 8), 6 LP connections and 6 Valve connections.

\* Solar Temperature Sensor required.

# Command Center Accessories

To expand the command center's functionality, component accessories (sold separately) can be incorporated into the initial installation or added later as needs change.

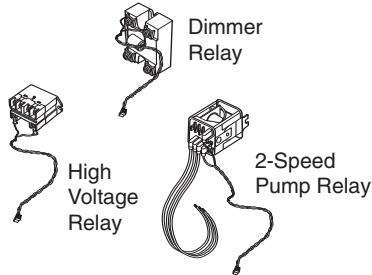

## Relays

Part #	Description
S30	• High Power Relay
S80	• Two-Speed Pump Relay
E75	• Dimmer Relay (2000 Watt Max.)

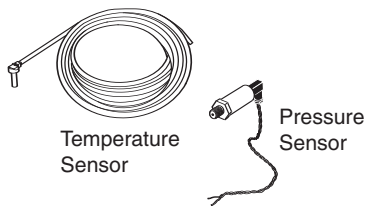

## Sensors

Part #	Description
S20	• Temperature Sensor, 15 Ft. Cable
S22	• Solar Temp Sensor, 50 Ft. Cable
S25	• Solar Temp Sensor, 100 Ft. Cable
E71	• Pressure Sensor, 20 Ft. Cable

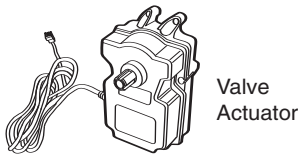

## Valve Actuator

Part #	Description
S10	• Automatic Valve Actuator



## Surge Protection

Part #	Description
S50	• Surge Protection Module (Lightning Protection)

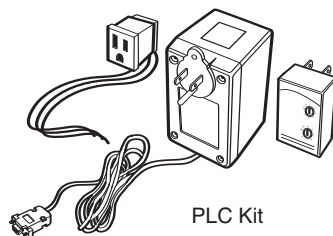

## PLC

Part #	Description
E40	• PLC Kit (Transmitter, Outlet and E41) <b>Required for PLC Control</b>
E41	• PLC Dimmer Module (Lighting Only)
E43	• PLC Appliance Module
E44	• PLC Screw-In Dimmer Module (Lighting Only)
E45	• PLC Phase Coupler, 3-Wire Plug-In
E46	• PLC Phase Coupler, Hardwired

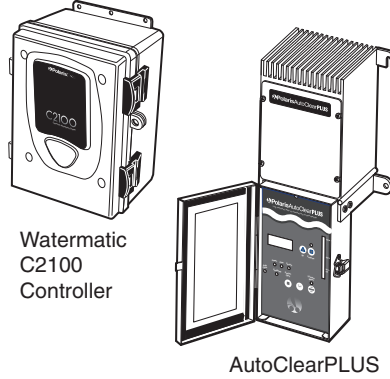

## Controllers

Part #	Description
C2100	• Polaris Watermatic C2100 ORP/pH Controller
E69	• CPC Extension Kit
85-600	• Polaris AutorClearPLUS Salt Chlorinator

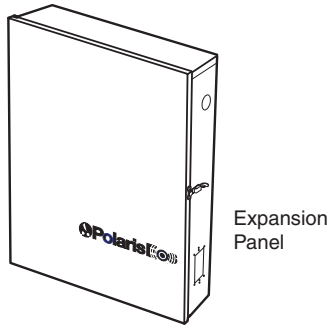

## Expansion Panel

Part #	Description
E9	• Expansion Panel Provides additional device hookups: 4 HP (4 more optional, max. 8) 6 LP and 6 Valve
E69	• CPC Extension Kit

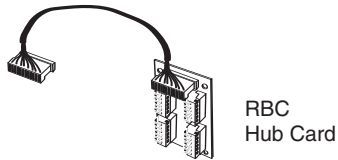

## RBC

Part #	Description
E34	• RBC Cable, 250 Ft.
E35	• RBC Cable, 500 Ft.
E36	• RBC Hub Card

## Remotes

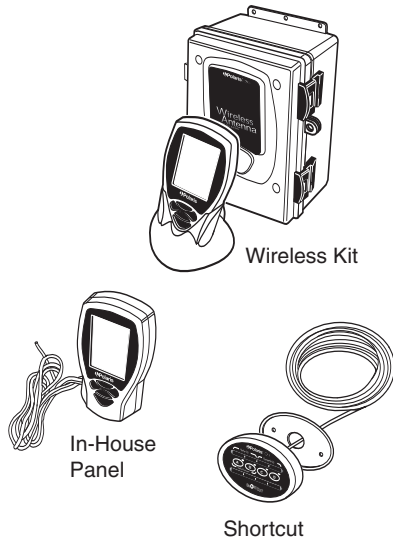

Part #	Description
E20	• Wireless Remote Kit (Antenna, Remote and Charging Base) <b>Required for wireless control.</b>
E21	• In-House Panel (Wired Remote) with 125 Ft. Cable
E22	• Shortcut Remote with 125 Ft. Cable
E23	• Shortcut Remote with 250 Ft. Cable
E24	• Shortcut Remote with 500 Ft. Cable
E29	• Wireless Remote with Charging Base
E30	• Wireless Remote Only
E31	• Wireless Remote Charging Base Only
E32	• Wireless Antenna Only
E33	• Wireless Remote Battery

## Eos PC Access

Part #	Description
E82	• Eos PC Access and Datalogger Applications

# Installation



## System Plumbing Guidelines

### Pool and Spa Combination

Plumb the system in accordance with the standard configuration of a pool and spa that share the same filter pump, filter and heater. The suction and return actuators will turn at the same time to switch between the pool, spa and spillover modes.

- Position the spa at or above the level of the pool. If the spa is attached to the pool, utilize an overflow dam between the two bodies of water. If the spa is not attached, install an equalizer line that can carry full pump-flow between the spa and pool.
- Plumb a 3-port valve on the suction side of the pool filter pump with the center valve port connected to the filter pump. Connect the spa suction to one side and the pool suction to the other.
- Plumb a 3-port valve on the heater output with the center valve port connected downstream of the heater. Connect the spa return to one side and the pool return to the other.
- Plumb a check valve on the spa return line if the pool/spa combination has an elevated spa.

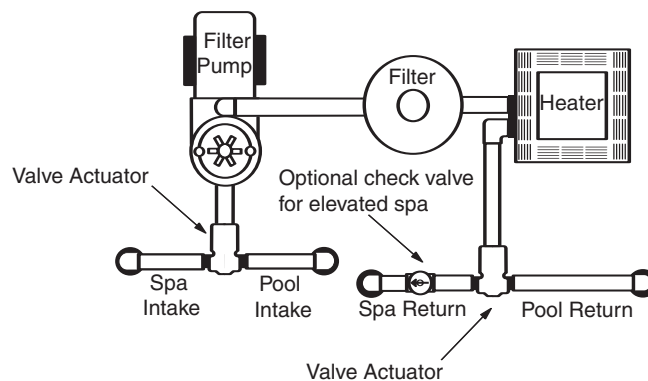



## Non-Booster Pump Cleaner

Plumb a 3-port valve on the pool return line after the spa and pool return valve. Connect the pool return to one port and the cleaner dedicated line to the other port.

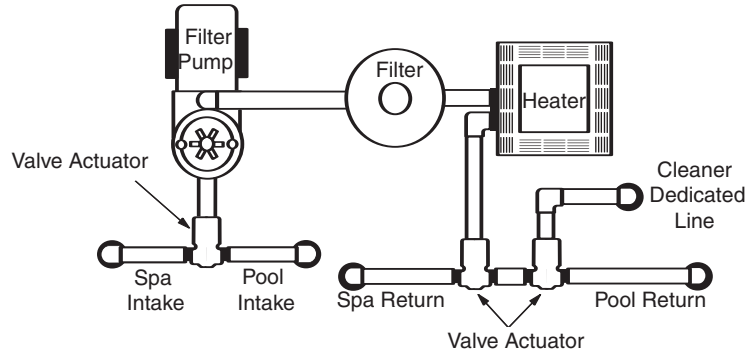

## Booster Pump Cleaner

Plumb the booster pump so the suction side is connected downstream of the heater and 3-port valve on the pool return side, as near to the ground as possible.

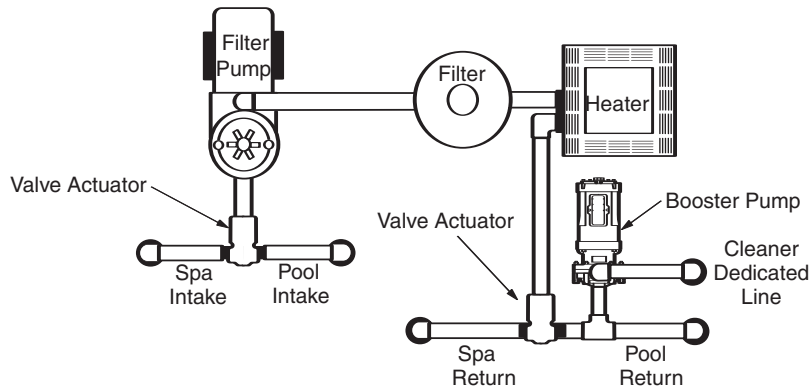

## In-floor System

Plumb the valve after the heater and before the in-floor unit.

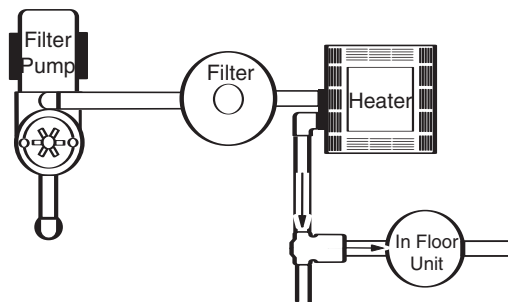

## Solar System

Plumb the solar feed and return lines before the heater.

- Install a 3-port solar valve and actuator at the feed line.
- A solar temperature sensor (50 ft or 100 ft) will be needed and should be mounted on or near the solar panels.

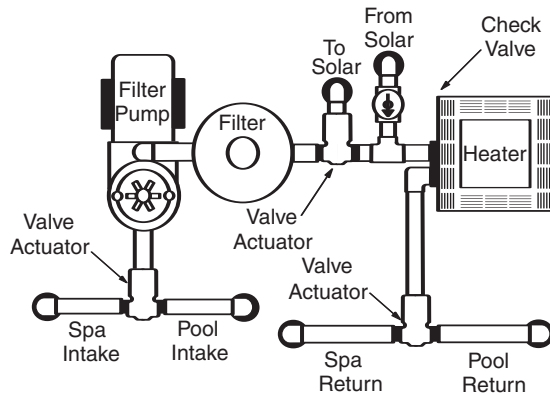

## Waterfall/Water Features

Plumb the water feature line with a 3-port valve and actuator.

- Use a separate pump if the water feature has its own suction supply and requires a large volume of water.

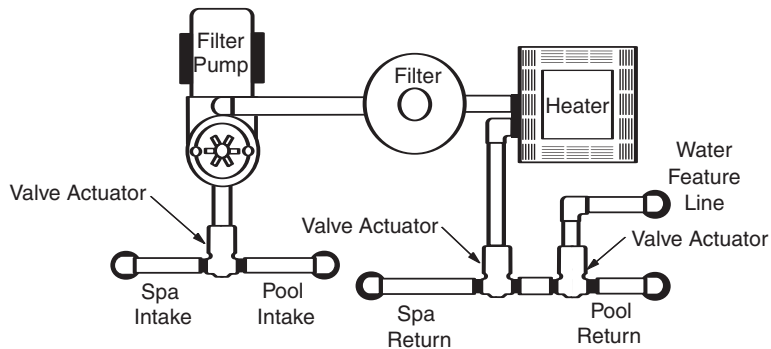



## Command Center Installation

**CAUTION:** Verify that power is disconnected before performing any installation or modification.

1. Attach the mounting brackets (shipped inside the controller) to the command center so that the brackets extend for hanging. To facilitate function setup and adjustments, mount the command center at eye level, at least 5 ft. (1.5 m) from the pool or spa.
2. Open the command center door and remove the deadfront to gain access to the electrical components.

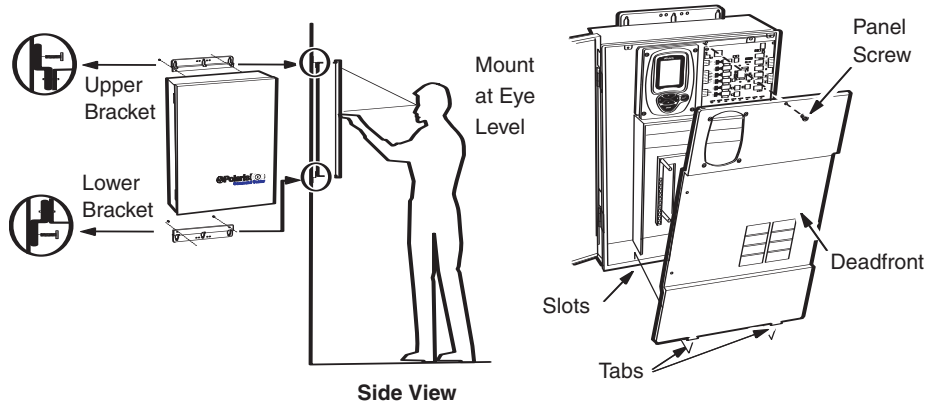

3. Run conduit from the power supply panel to the command center. The number of pieces of equipment to be controlled will dictate the size of the conduit.
4. Run wire from service panel to the Eos Command Center using minimum wire specifications listed on the wiring diagram on the command center door.
5. Connect input to lugs on the breaker subpanel.
6. Install circuit breakers per table on wiring diagram on command center door.
7. Connect transformer wires to a 120V circuit breaker.
8. A GROUND bar terminal is located on the panelboard in the Command Center. Per National Electrical Code (NEC) Article 250-122, this terminal must be connected to the ground means on the electric service or supply panel with a continuous copper (minimum 8 AWG (8.4 mm<sup>2</sup>) insulated wire.





9. Use an insulated or bare copper conductor no smaller than No. 8 AWG (US) or No. 6 AWG (Canada) to connect the local common bonding grid in the area of the pool or spa to the bonding lugs at the bottom right corner of the command center. Bond all field-installed metal components (rails, ladders, drains, etc.) located within 5 feet (1.5 m) of the pool or spa.
10. Pull wire, sized appropriately for each piece of equipment, from the equipment to the command center enclosure. Feeder wires should be No.14 AWG to No. 3 AWG, copper, rated for 750° F or better.

### Important Information Before Continuing

- Each piece of equipment normally requires its own high-voltage relay. If one relay is used for more than one device, verify that the total current draw (all equipment) does not exceed the current rating of the circuit.
- Ensure that all equipment motors have built-in thermal protection.
- Use the ground bar terminal in the command center for equipment grounding.
- Install an external surge suppression device (Surge Protection Module, part #S50) in areas where lightning strikes are common.
- Use the rectangular knockout on the side of the command center enclosure to mount an approved GFCB or GFCI if direct connection of underwater lights is planned. If installed outdoors, an approved rain cover must be installed over the device. Refer to NEC 680-21 (b) or CEC 687-060, 062, and 066 for further details.
- If installing a **Wireless Remote Kit**:

Plan for antenna installation at a location where reception is best, generally in the center of the coverage area. Test for signal reception from various locations in the coverage area before permanently installing antenna.

Be aware of factors that inhibit/prevent communications, such as:

- |                 |                                   |
|-----------------|-----------------------------------|
| Aluminum siding | Mylar protected windows and doors |
| Cyclone Fences  | Gas filled windows and doors      |
| Wrought iron    | Microwave ovens                   |
| Steel framing   | Other 5.6 GHz frequency devices   |
| Leaded glass    |                                   |

Ensure that the battery in the handheld remote is fully charged i.e., charged on charging base, for at least five (5) hours.



# HP (High Power) Devices

High power devices include pumps, lights, blowers, electric heaters and any other 120/240V device under 3HP or 1500 watts.

Four HP Relays (HP1-HP4) are prewired to the Eos activator board. Four additional HP Relays (part #S30) can be added if needed.



**CAUTION: Verify that power is disconnected before performing any installation.**

1. Pull equipment wiring through knockouts on the bottom of the command center box.
2. Using any HP Relay, connect the device to the Eos relay panel.

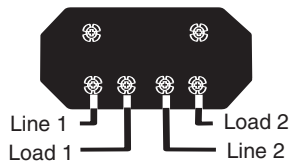

3. Use a relay identifier label to mark the relay connection at the activator board.

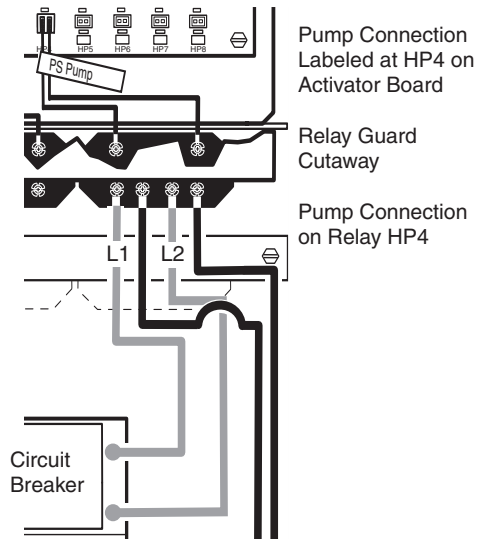

4. Connect equipment grounds to ground bar terminal.
5. When all connections are complete, all HP Devices will be defined and assigned to the associated relays as part of System Setup.

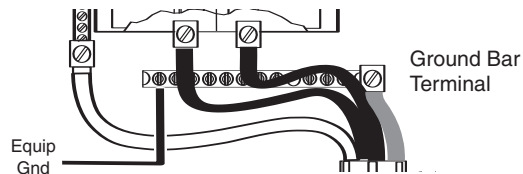

## To connect a fiber optic light driver like Polaris AfterDark®:

Use two relays, one for the light driver power and one for color wheel control.

First relay:

- Line 1 to the circuit breaker.
- Load 1 to light driver power wire.

Second relay:

- Line 1 and Load 1 to the color wheel control wires.

Light driver neutral to Eos neutral bar  
Light driver ground to Eos ground bar.

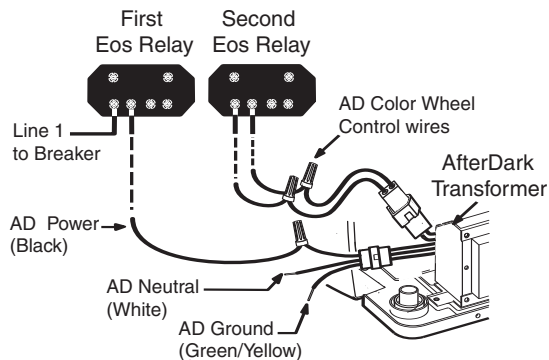



LP Devices

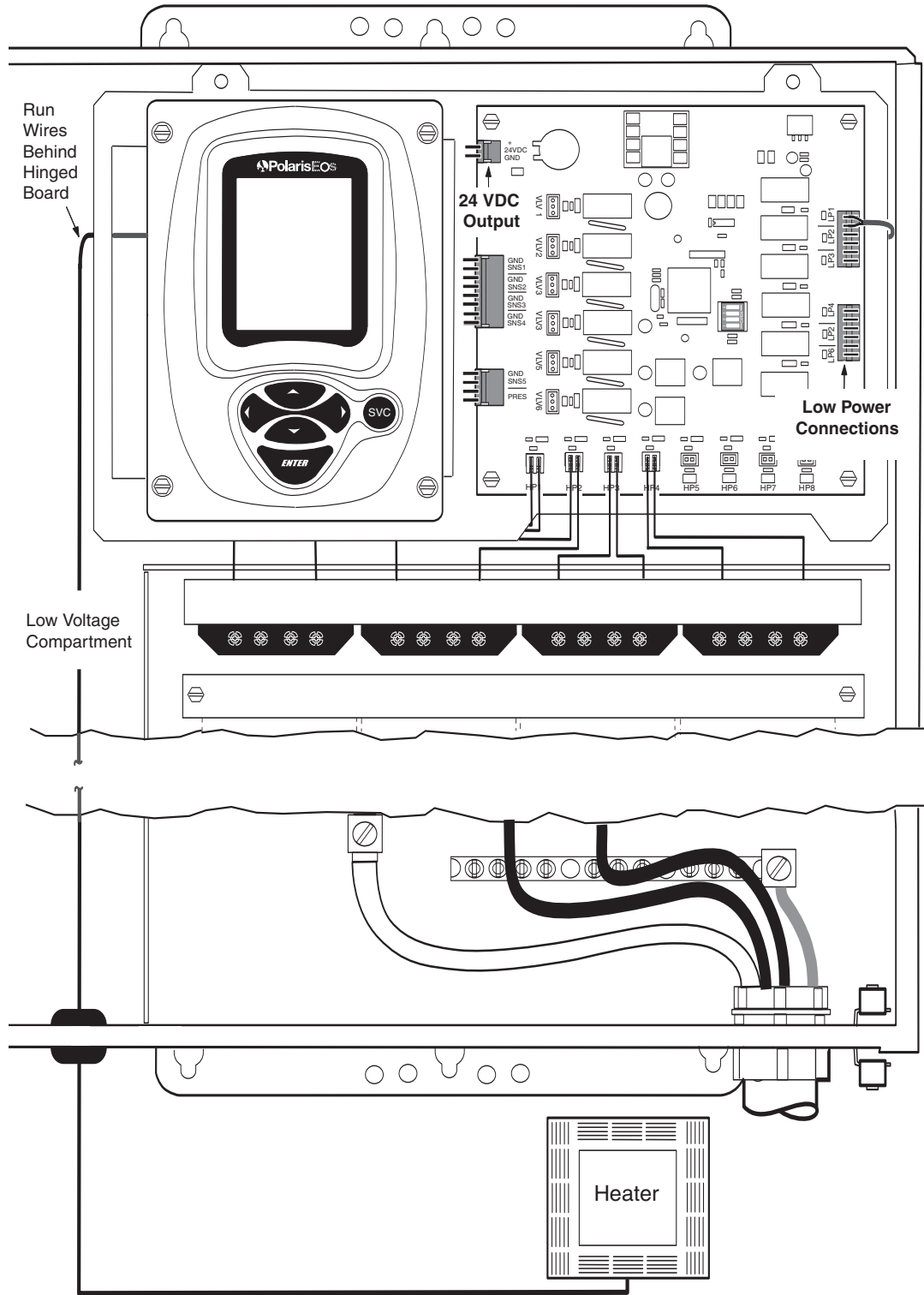

## LP (Low Power) Devices

The six low power terminal connections are for heater control circuits, heat pump control circuits, self-powered landscape lighting, etc. **These connections are “switch only,” with no power provided.**

The Low Power connections are labeled LP1-LP6 on the Eos activator board.



**CAUTION: Verify that power is disconnected before performing any installation or modification.**

1. Run equipment wires up through low voltage compartment and behind hinged board plate.

If connecting a heater, use 18 AWG wire suitable for use in hot environments. For heater specific wiring instructions, refer to the manufacturer’s manual.

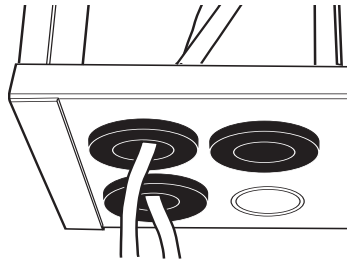

Wiring run through grommets at low voltage compartment

2. Connect the device to any LP terminal, positions LP1-LP6, on the Eos activator board.

A 24 VDC output (.5A max.) is provided for powering low voltage triggers on equipment. This output can be run through a LP relay so it is switched manually or scheduled. This output is not for use with heater connections.

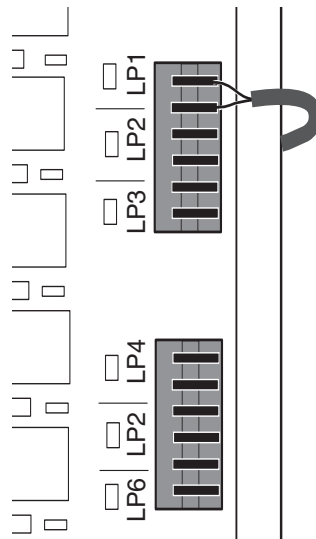

Heater connected at LP1 position on Activator Board

3. When all connections are complete, all LP Devices will be defined and assigned to their associated terminal positions as part of System Setup.



Valves

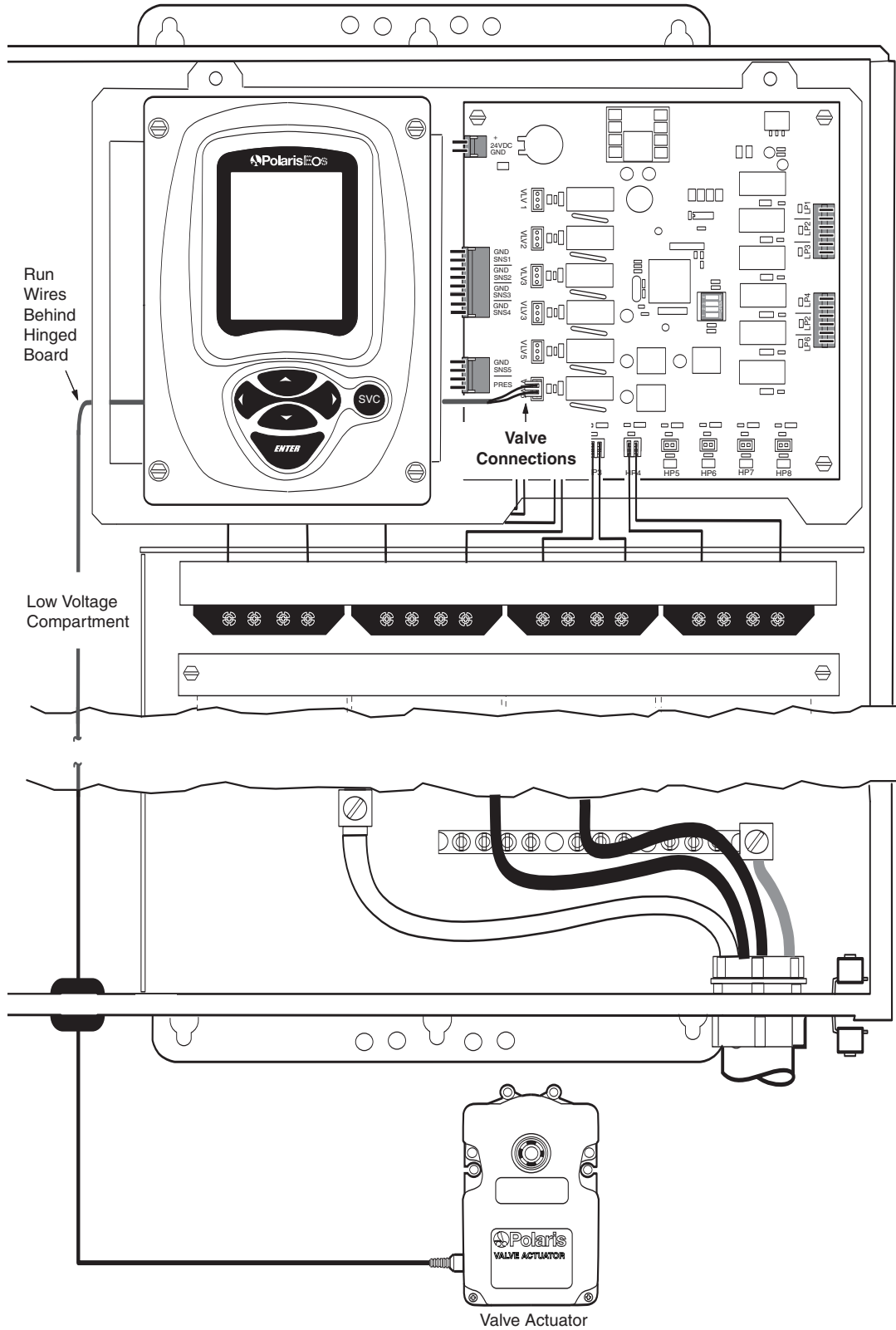

# Valve Actuators

The Eos can control up to six Valve Actuators (part #S10). These can be used to control the suction and return valves for the pool or spa, spa-dependent valves, waterfall, water feature and cleaner valves, and in-floor system valves.

The Valve connections are labeled VLV1-VLV6 on the Eos activator board.



**CAUTION: Verify that power is disconnected before performing any installation or modification.**

1. Run actuator wires up through low voltage compartment and behind hinged board plate. **Do not coil actuator cable inside the command center.**

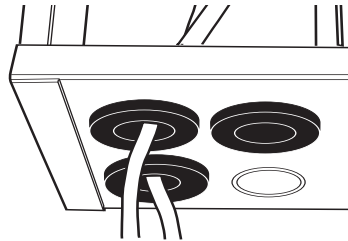

Wiring run through grommets at low voltage compartment

2. Connect the valve wires to any VLV terminal block on the Eos activator board.

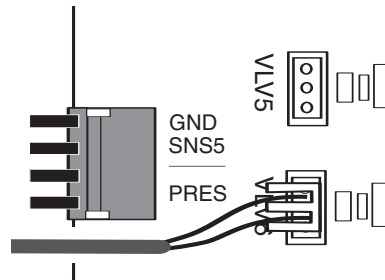

Valve Actuator connected to VLV6

3. When all connections are complete, all valve actuators will be defined and assigned to the associated valve terminals as part of System Setup.

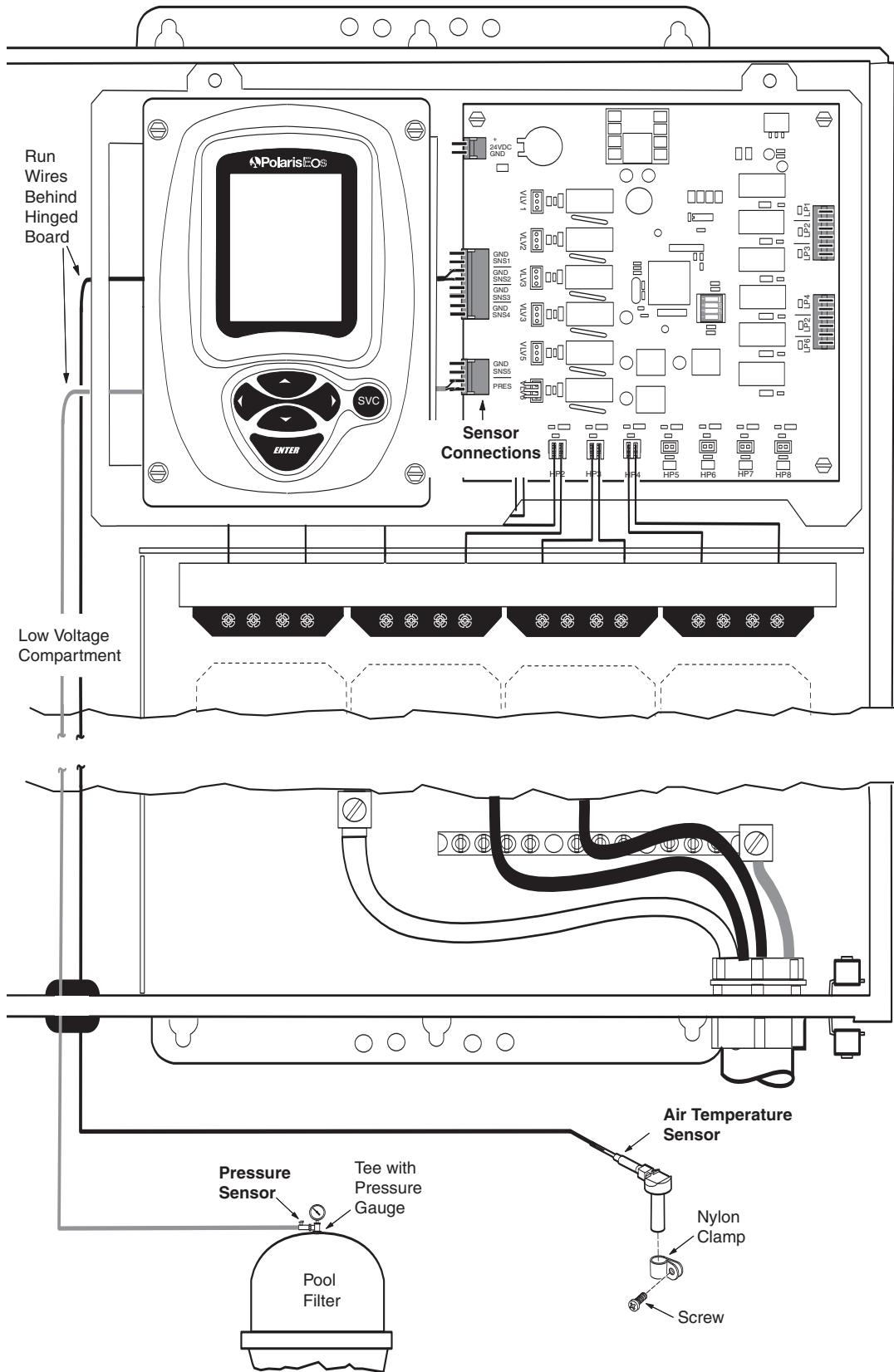

# Sensors



Two standard sensors are included with the Eos system, typically one water and one air temperature sensor. There are four additional terminal positions available, three for optional temperature sensors and one for an optional filter Pressure Sensor (part #E71).

The Sensor terminal on the Eos activator board is labeled SNS1-SNS5 and PRES.

## Water Temperature Sensor

Drill a 3/8" hole in the pipe between the filter pump and the filter.

Insert the sensor using the clamp provided to hold it in place.

Verify that the o-ring is securely around the sensor to ensure a watertight seal.

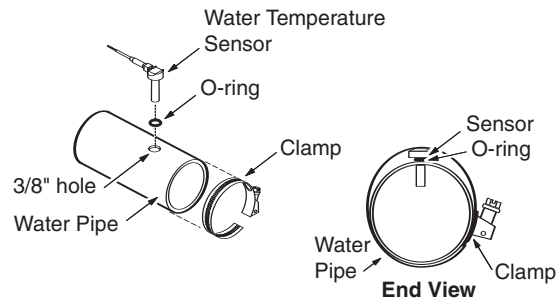

## Freeze/Ambient Air Temperature Sensor

Install the sensor outside of the command center in an area where it is subjected to shaded air temperature, not to direct sunlight.

## Filter Pressure Sensor

Install on the filter at the pressure gauge, either using the gauge connection or using a tee.

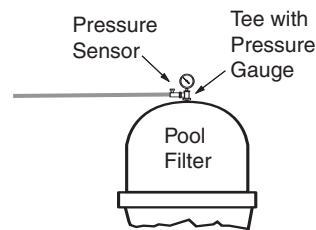

**CAUTION: Verify that power is disconnected before performing any installation or modification.**

1. Run sensor wires up through low voltage compartment and behind hinged board plate.
2. Strip insulation back 1/4" from end of wires. **Do not cut wires.**
3. Connect the temperature sensor and ground wires to any position (SNS1- SNS5) on the removable terminal block on the activator board.

Connect the pressure sensor wires, red to positive and black to negative, to the PRES terminal position.

4. When all connections are complete, the sensors will be defined and assigned to the associated terminal positions as part of System Setup.

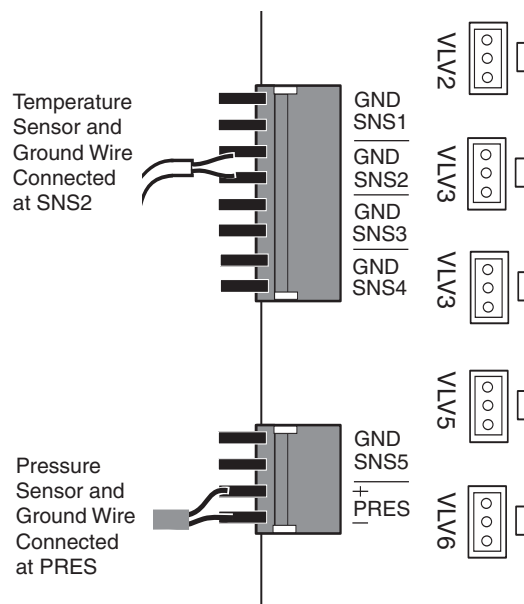

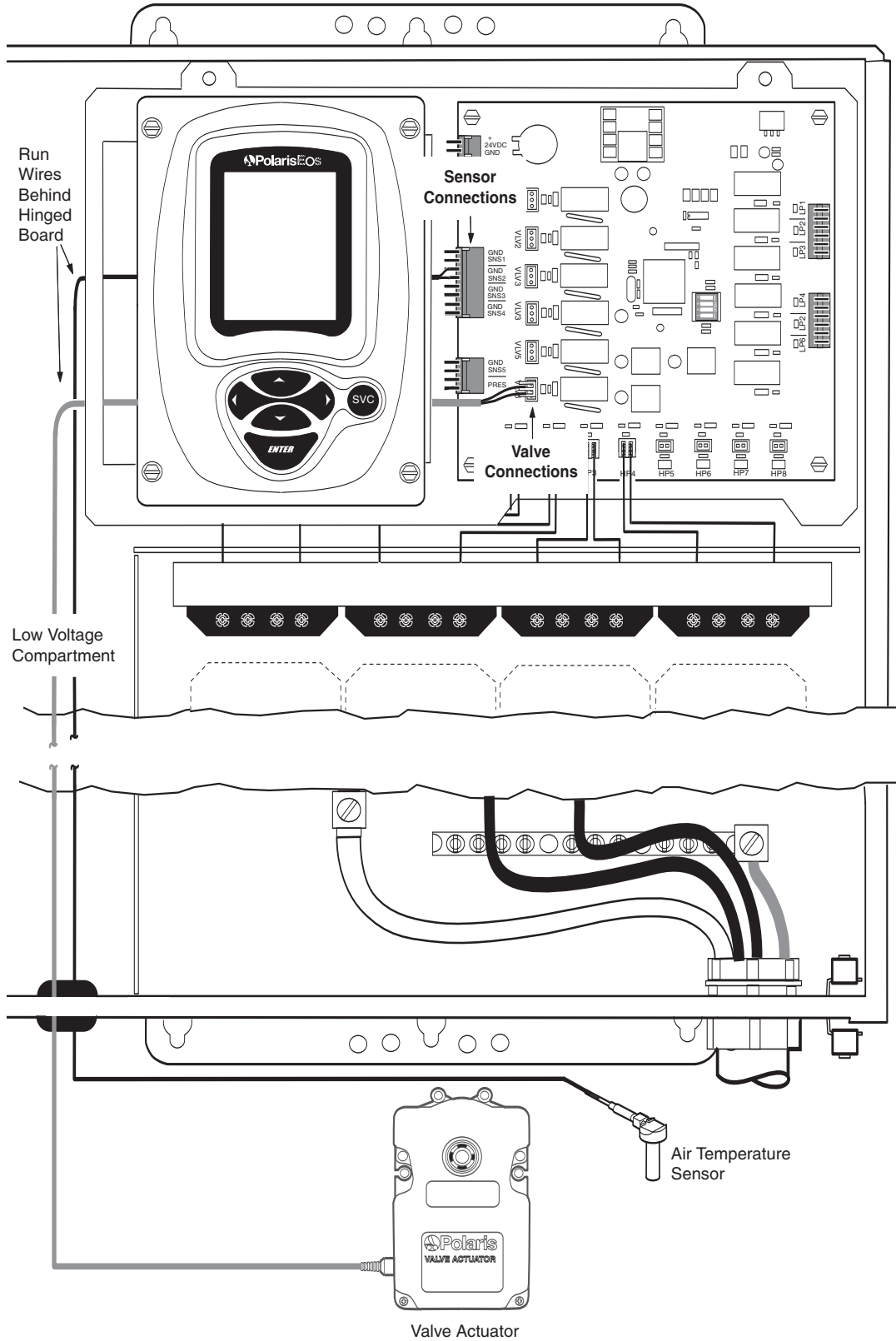

## Solar Temperature Sensor

If the application includes a solar system, a separate solar temperature sensor must be installed.

The solar heating feature will operate only if the solar sensor reads at least 5 degrees warmer than the pool water.

Position the solar sensor in the sun adjacent to the solar panels.

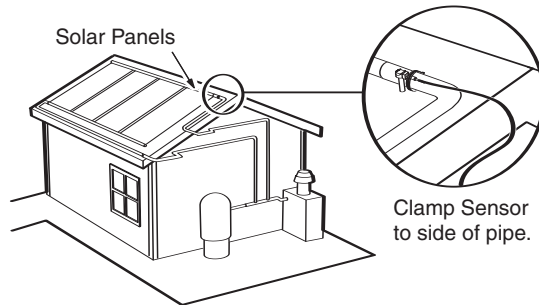

**CAUTION: Verify that power is disconnected before performing any installation or modification.**

1. Run actuator and sensor wires up through low voltage compartment and behind hinged board plate.
2. Connect the sensor to the SNS terminal block and the valve to the VLV terminal block on the Eos activator board.
3. If there is a booster pump on the solar system, connect the pump to any available HP relay.
4. When all connections are complete, the solar sensor, valve actuator, and pump if applicable, will be defined and assigned to the associated terminal positions as part of System Setup.

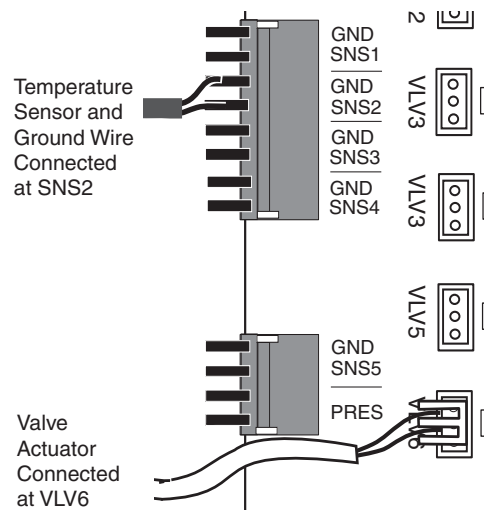

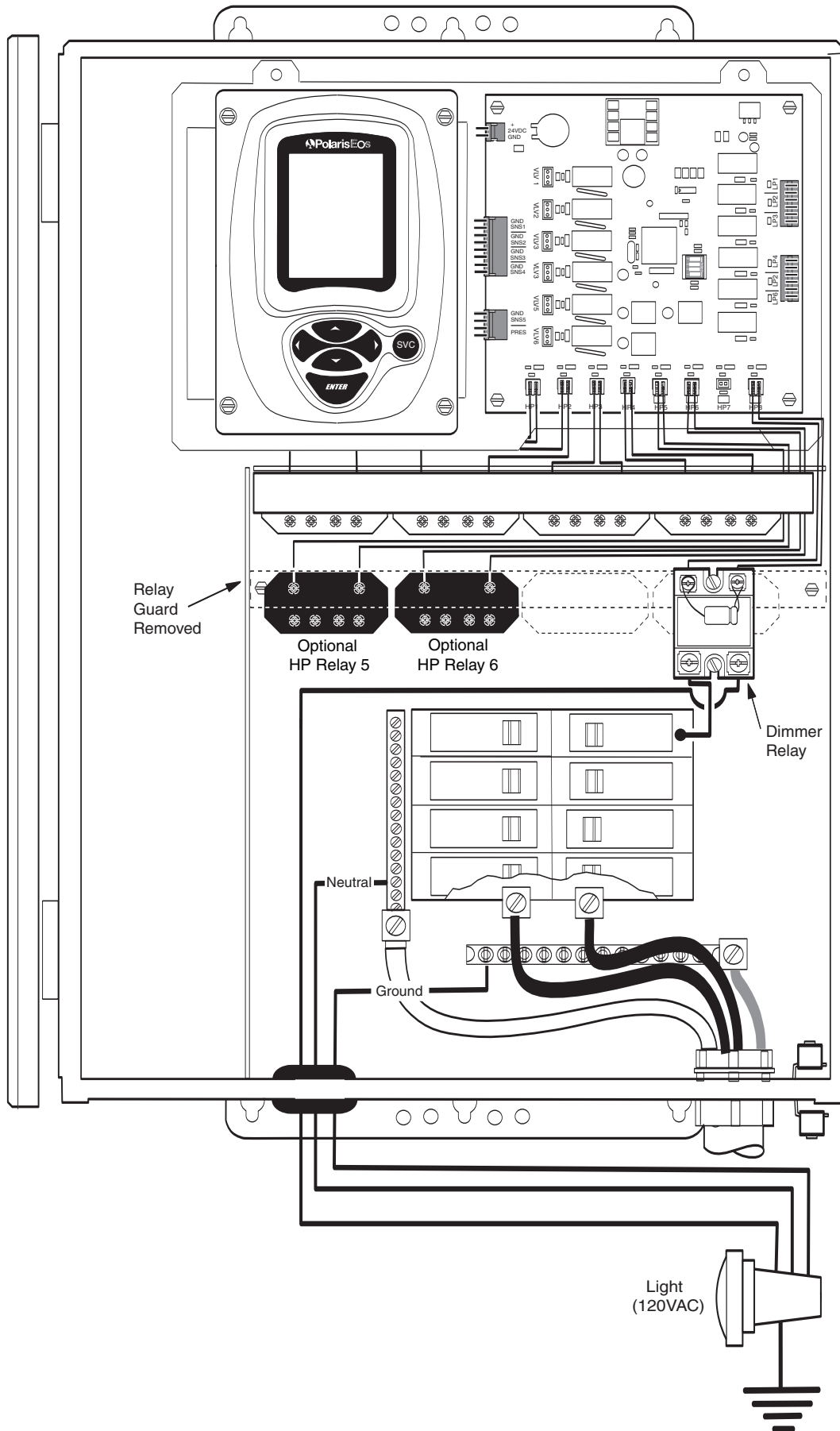

# Command Center Options



## Optional Relays

### Additional HP Relays (part #S30)

Up to four additional high power relays can be added to the command center relay panel.

**CAUTION: Verify that power is disconnected before performing any installation.**

1. Connect the relay to any open position on the lower portion of the relay panel.
2. Connect the relay wires to any open relay socket (HP5-8) on the command center activator board.

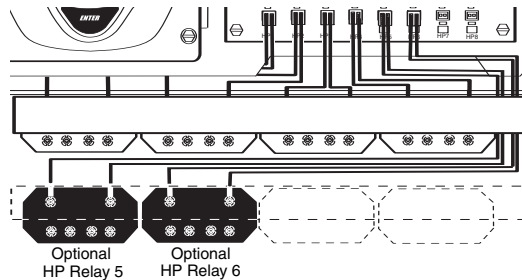

### Dimmer Relay (part #E75)

The Dimmer can be installed on either the HP7 or HP8 relay position on the lower portion of the command center relay panel.

**CAUTION: Verify that power is disconnected before performing any installation.**

1. Apply the thermal conductive compound (included) to the back of the dimmer.
2. Mount the unit vertically, with wire connections at top, using the predrilled holes. Connect the relay wires to any open relay socket (HP5-8) on the command center activator board.
3. Use a wiring identifier label to mark the connection at the activator board.
4. Connect one side of the dimmer to the transformer and the other side to the load line of the light.
5. When all connections are complete, the dimmer will be defined and assigned to the associated relay as part of System Setup.

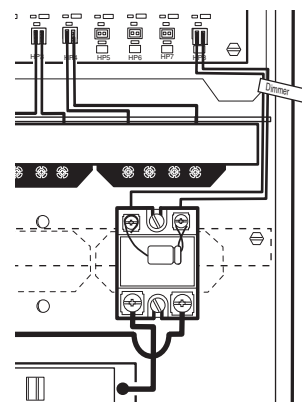
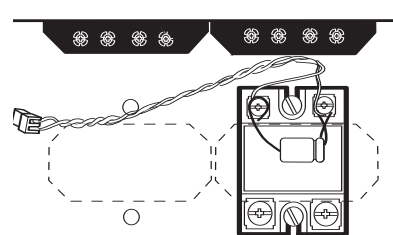

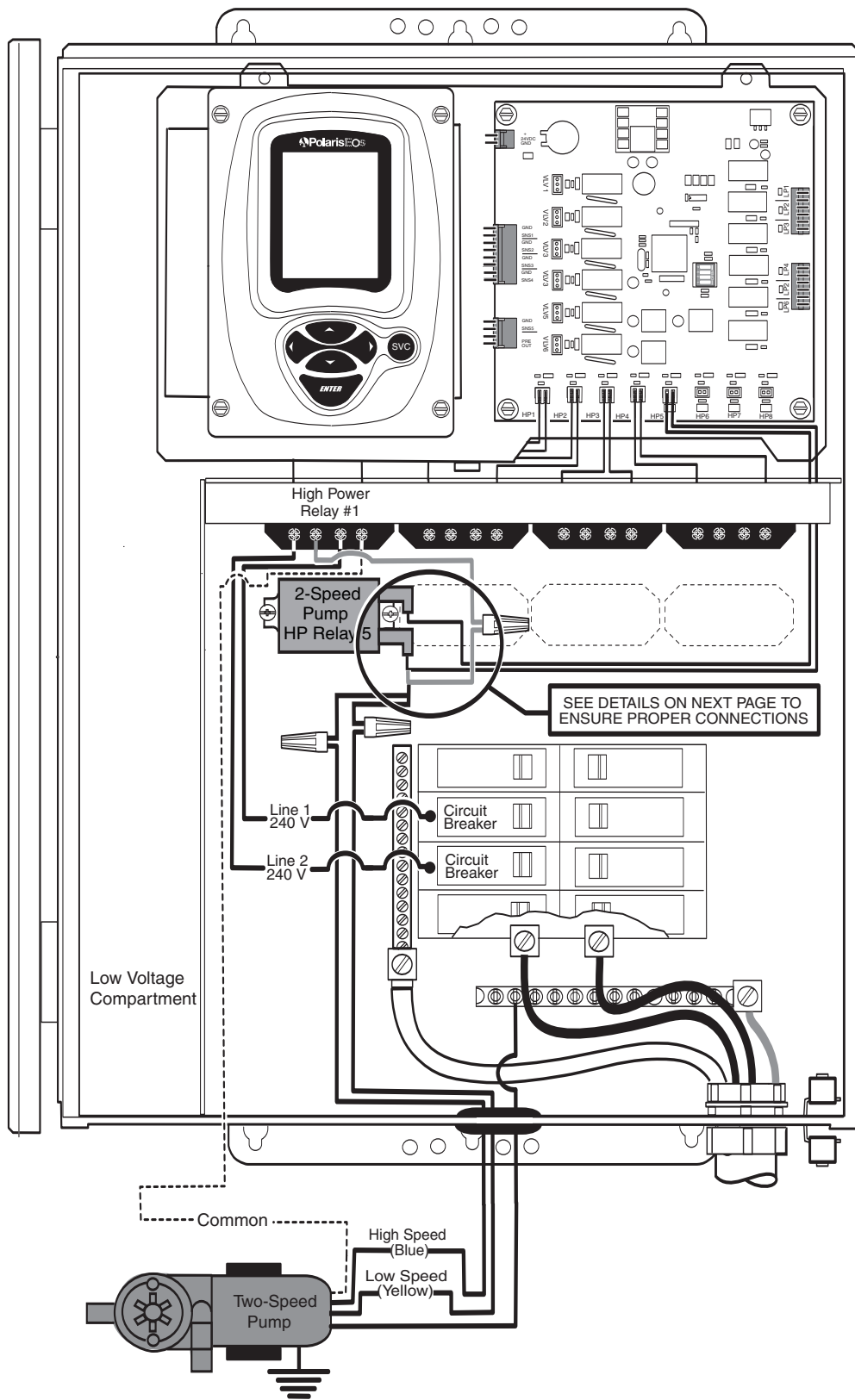



## 2-Speed Pump Relay (part #S80)

**CAUTION:** Verify that power is disconnected before performing any installation or modification.

1. Mount the 2-speed pump relay in any open high power relay position on the lower portion of the command center relay panel, HP5-HP8 positions.
2. Connect the relay wires to any open relay socket (HP5-8) on the command center activator board.

3. Use a wiring identifier label to mark the connection at the activator board.
4. Connect the motor and 2-speed relay load and line wires:

Pump Motor

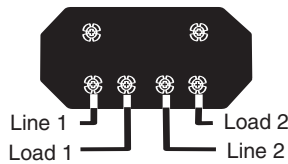

2-Speed Relay

- Low speed wire to Yellow wire
- High speed wire to Blue wire
- Common wire to one Load side of the filter pump relay
- Orange wire to other Load side of the filter pump relay

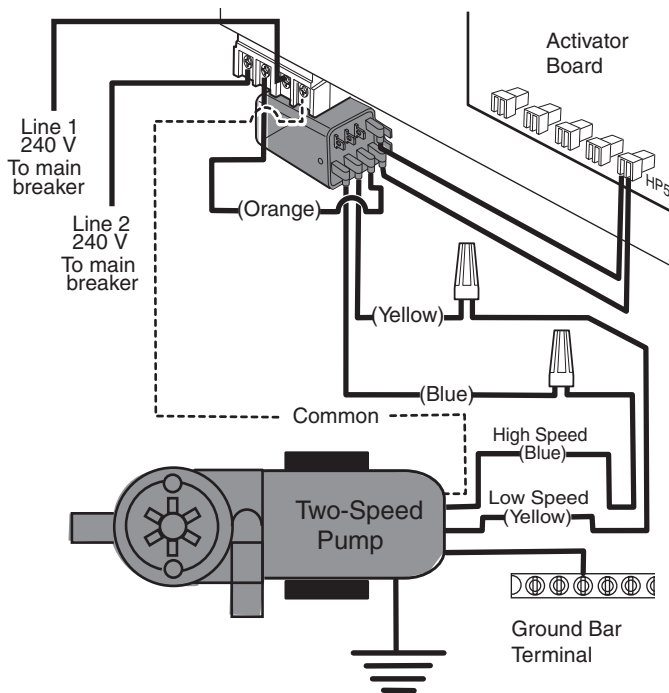

5. When all connections are complete, the standard relay for high speed and the 2-speed relay for low speed will be defined and assigned to their associated relays as part of System Setup.



Optional PLC Kit

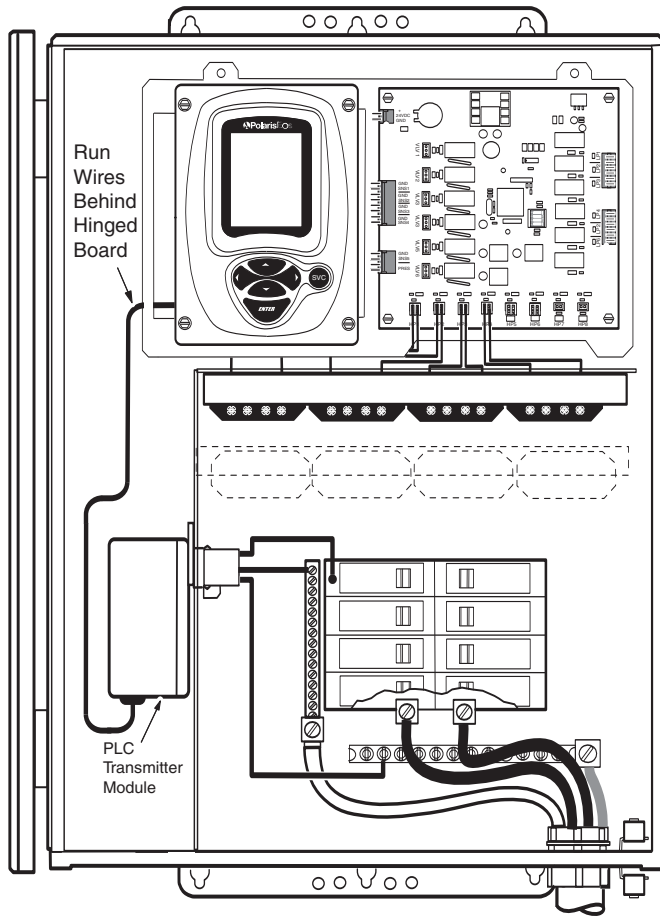

Eos Command Center with hinged board plate down

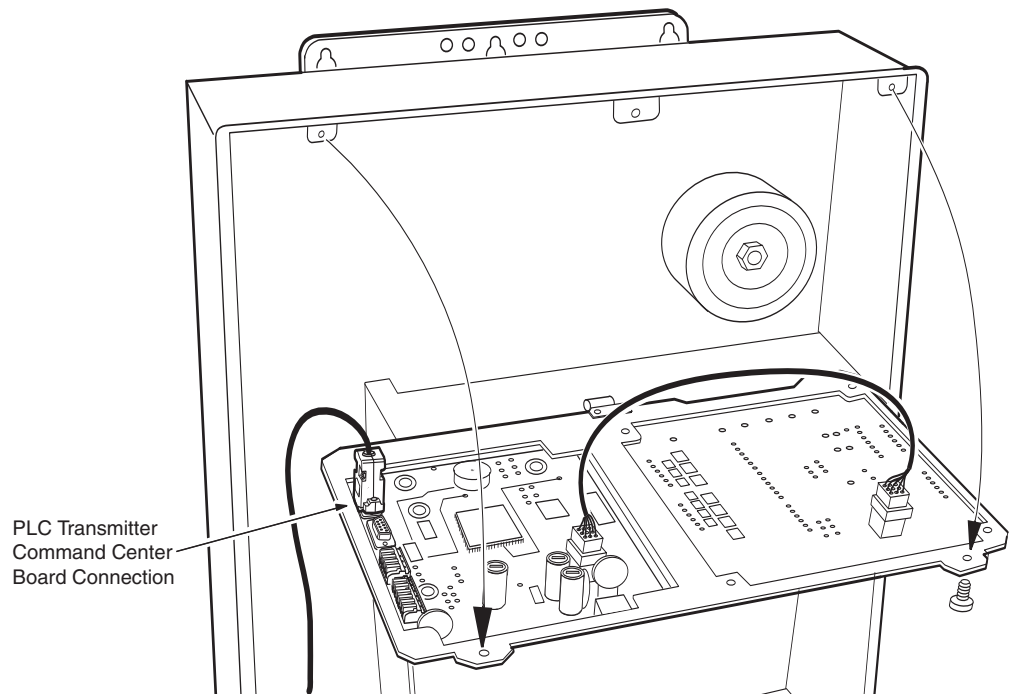



## Optional PLC (X-10) Kit (part #E40)

The PLC (Power Line Carrier) Kit provides a convenient, alternative method for controlling high power devices such as lights, stereos, fans and other appliances.

Devices plug into a small PLC Receiver Module that plugs into a regular wall outlet inside the house. **A separate receiver is required for each device.**

The receiver communicates with a transmitter module connected to the Eos Command Center. Once set up, the device can be toggled on or off as if it were wired directly to the Eos controller. Lamp dimmer modules also provide a percentage setting to produce bright or dim lighting. Up to 64 receiver modules can be assigned on the system.

PLC Kit includes:

- Transmitter
- Dimmer Module (Lighting only)
- Outlet

**CAUTION: Verify that power is disconnected before performing any installation or modification.**

1. Slide PLC Outlet wires through square cutout on inside wall of low voltage compartment. Ensure ground hole is at the bottom.

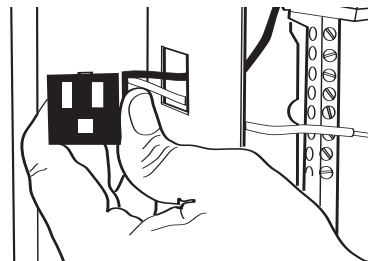

2. Snap outlet into place

3. Connect the outlet wires:

- Green to ground bar
- White to neutral
- Black to a 120V circuit breaker

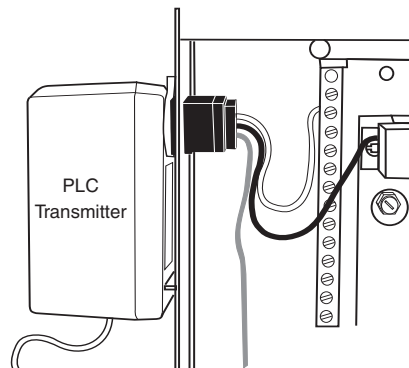

4. Plug the PLC Transmitter into the outlet. The cable should hang from the bottom.

5. Unscrew and swing down the hinged board plate. Plug the transmitter cable into the X-10 socket on the command center board.

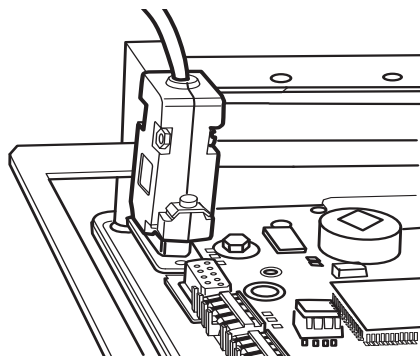



6. **A separate receiver module is required for each device.**

Use the dials on the front of the PLC receiver to set the house code (A-D) and device code (1-16). Make note of the codes for each device for use during System Setup.

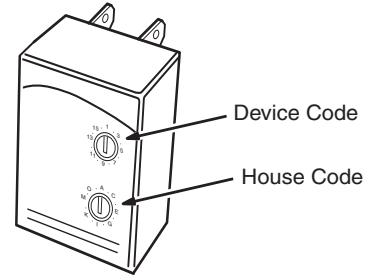

7. Plug the receiver module into any wall plug and the device into the receiver.

8. When all connections are complete, PLC devices will be defined as part of System Setup.

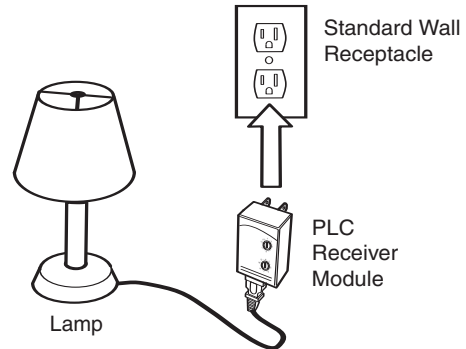

### Optional 240V Bridge

When house circuits are not linked to the Eos via the circuit breaker box, it may be necessary to add a bridge or phase coupler (part #E46) at the breaker box or directly onto the command center breaker subpanel.

If a 240V outlet, typical electric stove or dryer outlet, is available, the 3-prong, plug-in phase coupler (part #E45) can also be used.

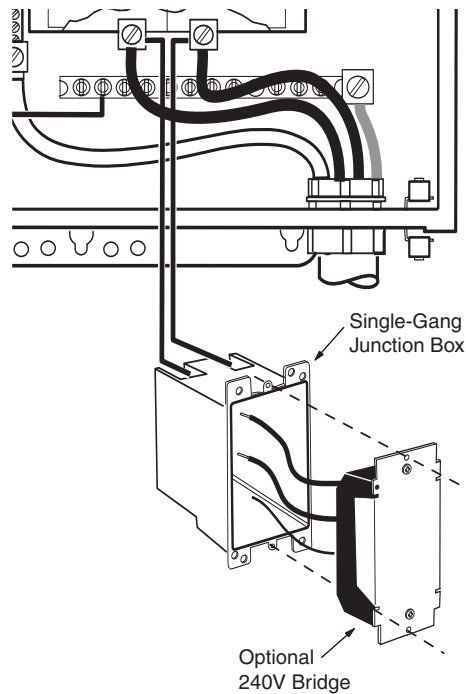

## Optional Expansion Panel (part #E9)

The Expansion Panel provides 8 additional high power connections (4 relays are included), 6 low power connections, 6 valve connections and 6 sensor (5 temperature and 1 pressure) connections.

The Eos system can accommodate up to three Expansion Panels to provide up to 32 high power, 24 low power and 24 valve connections.

Mount the Expansion Panel within 12 feet of Eos Command Center to accommodate the CPC Cable connection. If a longer CPC cable is needed, order the CPC Extension Kit (part #E69).



**CAUTION: Verify that power is disconnected before performing any installation or modification.**

1. Open expansion panel door and remove deadfront to access electrical panel.
2. Run appropriately sized conduit and wire from the main power supply to the panel.
3. Connect input to lugs on the breaker subpanel and install circuit breakers.
4. Connect white transformer wire to a 120V circuit breaker.
5. Connect ground means on the electric supply service panel to the lug on the GROUND bar terminal on the expansion panelboard using continuous copper (minimum No. 8 AWG) bare, covered or insulated wire.
6. Use insulated or bare copper conductor, no smaller than No. 8 AWG (No. 6 AWG for Canada), to connect the local common bonding grid in the area of the pool or spa to the bonding lugs on the expansion panel box.

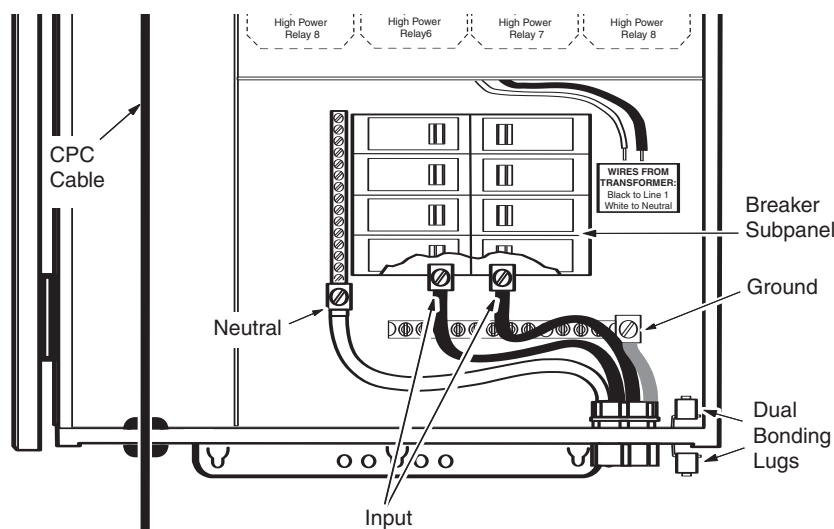

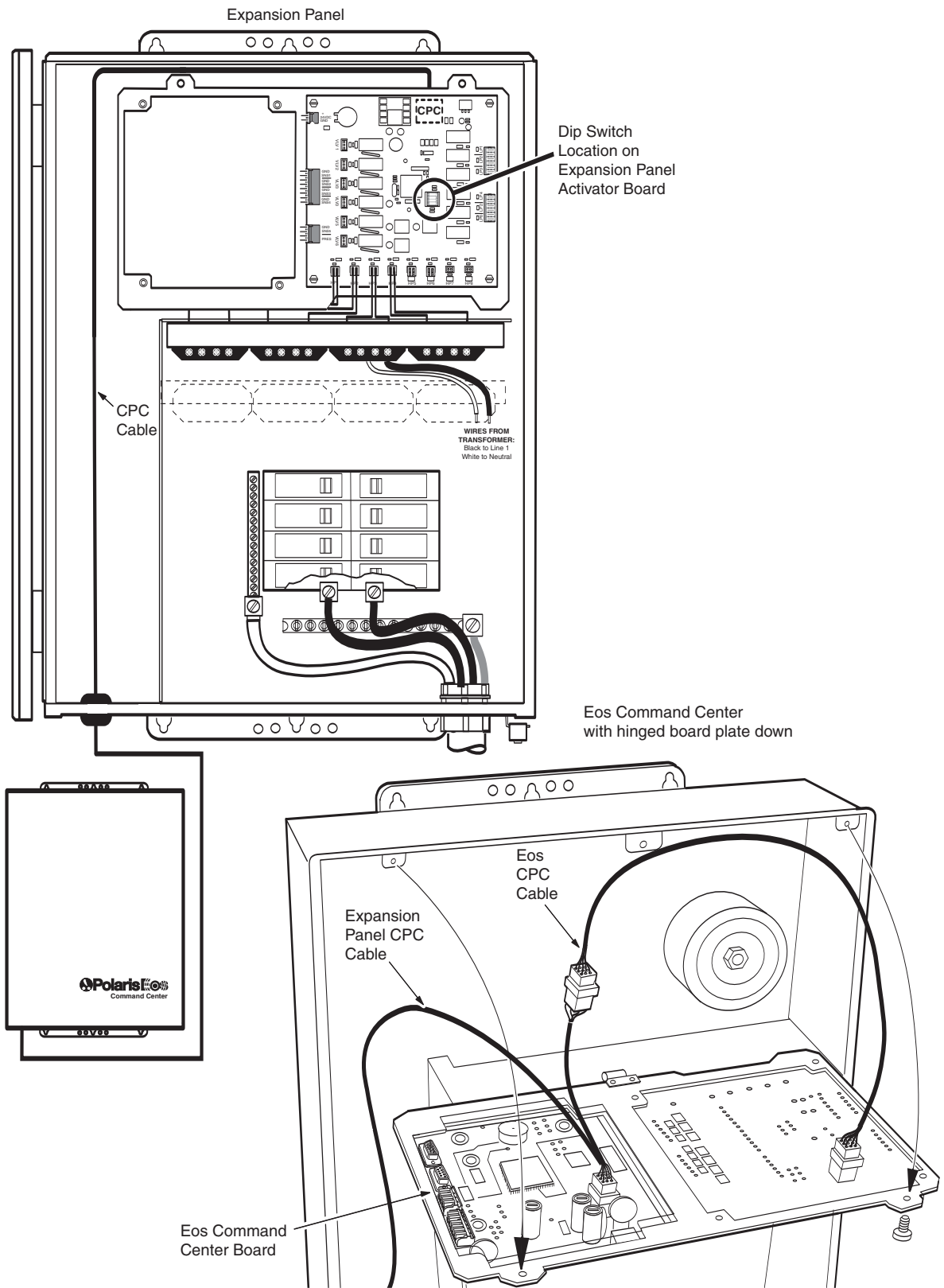



7. Locate the dip switches on the expansion panel activator board and verify that they are set appropriately.

The panel is shipped as Activator #2, so subsequent panels will need to be adjusted.

Dip Switch Positions for First Expansion Panel

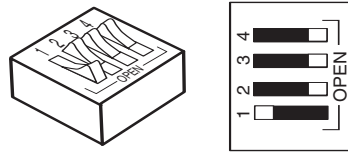

Unit	Activator	Dip Switch Settings
Command Center	#1	All dip switches open
First Expansion Panel	#2	Close position #1
Second Expansion Panel	#3	Close position #2
Third Expansion Panel	#4	Close position #1 and #2

8. Unscrew and swing down the hinged board plate to access the circuit board.

9. Route the expansion CPC cable up through the low voltage compartment.

10. Connect the 9-pin CPC connector to the activator board and the 2-pin connector to the transformer connector.

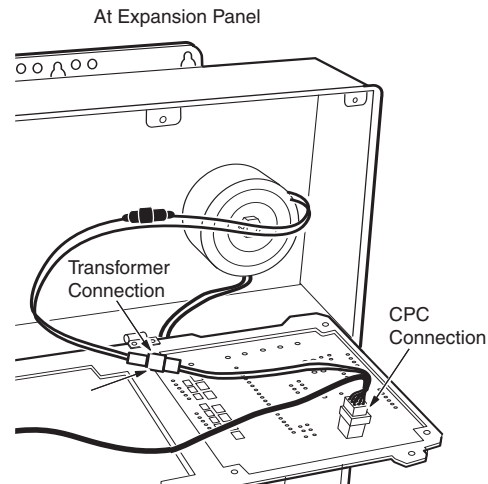

At the Eos Command Center:

1. Route the expansion panel CPC cable through the low voltage compartment.

2. Unplug the Eos CPC cable from the command center board.

3. Plug one end of the expansion CPC cable into the command center board and the other end into the CPC cable connected to the activator board.

If multiple expansion panels and/or a Watermatic C2100 is being installed, daisy chain the command center connection to accommodate all the units.

4. Follow the instructions specified in this manual to connect and set up equipment on the expansion panel.

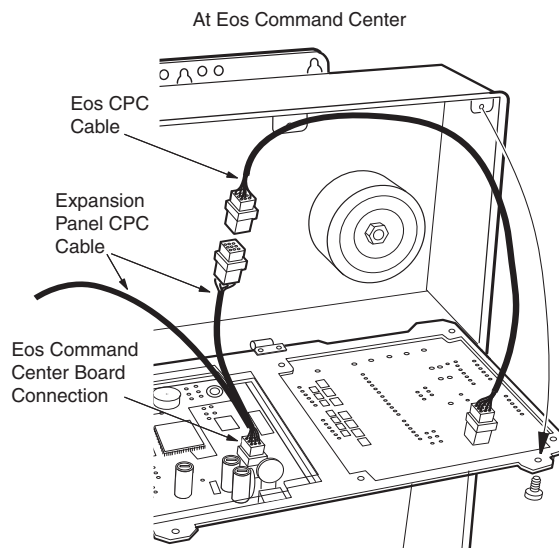

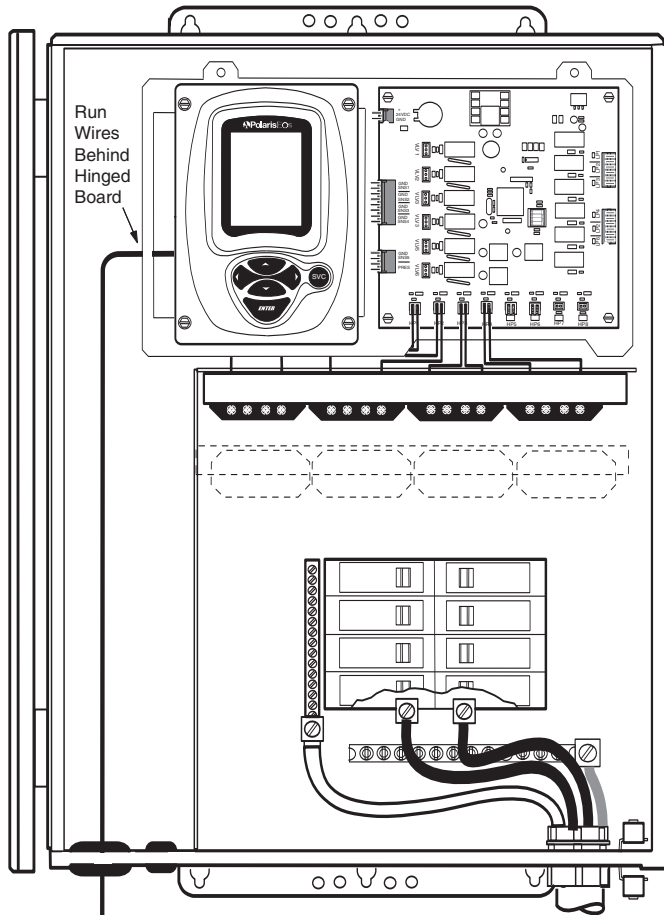

Eos Command Center with hinged board plate down

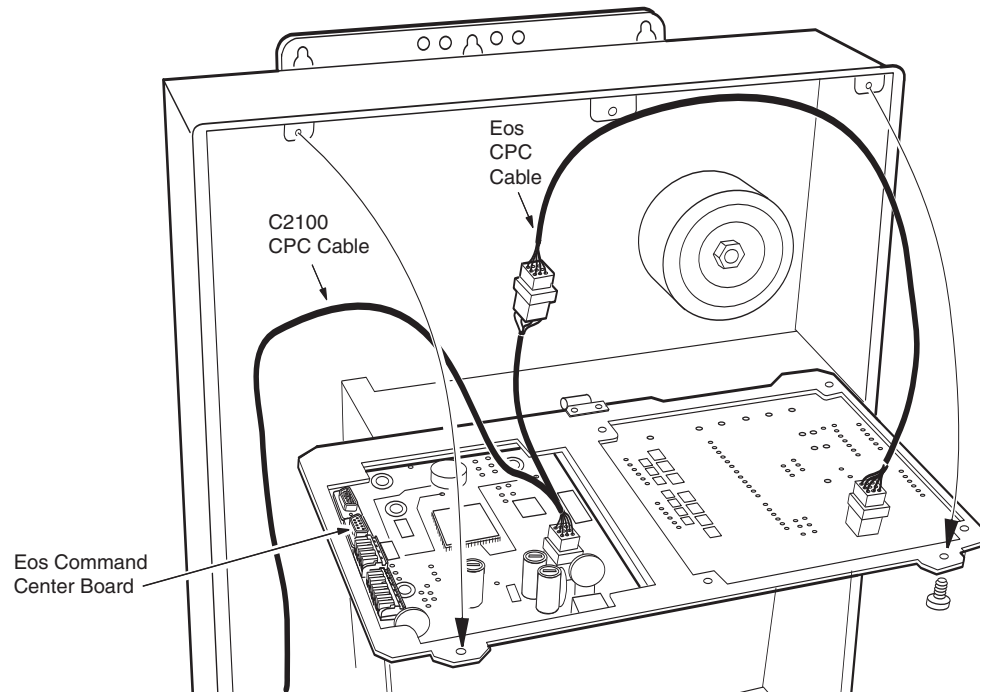
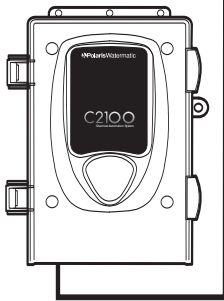

# Optional Controllers



## Polaris Watermatic C2100 ORP/pH Controller (part #C2100)

ORP and pH level monitoring and control are available with the Eos when the Polaris Watermatic C2100 controller is installed on the system. Eos can accommodate two Watermatic controllers.

Refer to the controller owner's manual for complete installation instructions. Mount the controller within 12 feet of the Eos Command Center to accommodate the CPC Cable connection. If a longer CPC cable is needed, order the CPC Extension Kit (part #E69).

**CAUTION: Verify that power is disconnected before performing any installation.**

At the C2100 controller:

1. Open the door to the controller.
2. Connect the CPC cable to the controller circuit board.
3. Remove wire clamp, route the CPC cable through the housing grommets. Replace wire clamp and close door.
4. Run CPC cable to the command center.

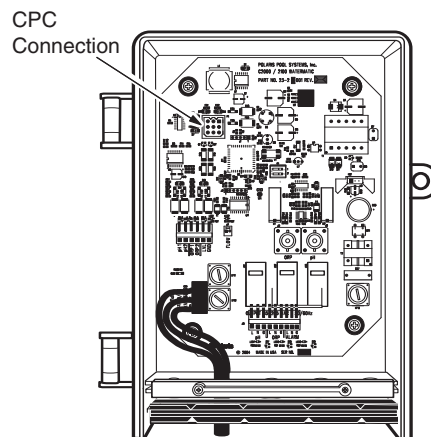

At the Eos Command Center:

1. Unscrew and swing down the hinged board plate to access the command center circuit boards.
2. Route the C2100 CPC cable through the low voltage compartment.
3. Unplug the Eos CPC cable from the command center board.
4. Plug one end of the C2100 CPC cable into the command center board and the other end into the Eos CPC cable connected to the Eos Activator Board.

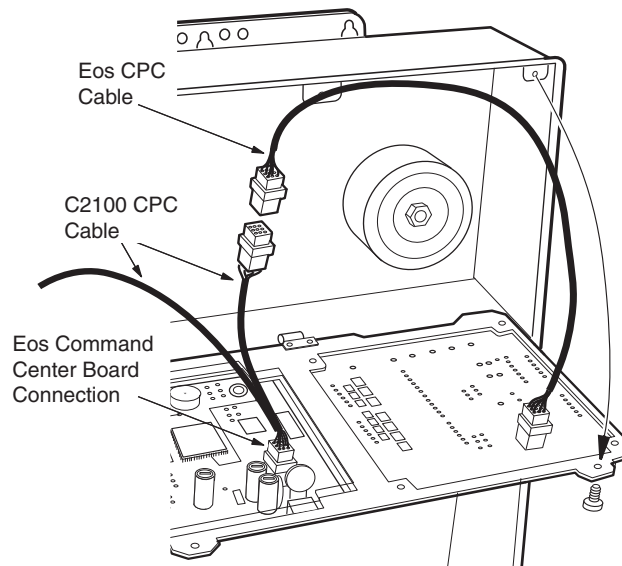

If the Watermatic will control a Polaris AutoClearPLUS for chlorination, refer to the installation instructions in the Salt Chlorinator section.

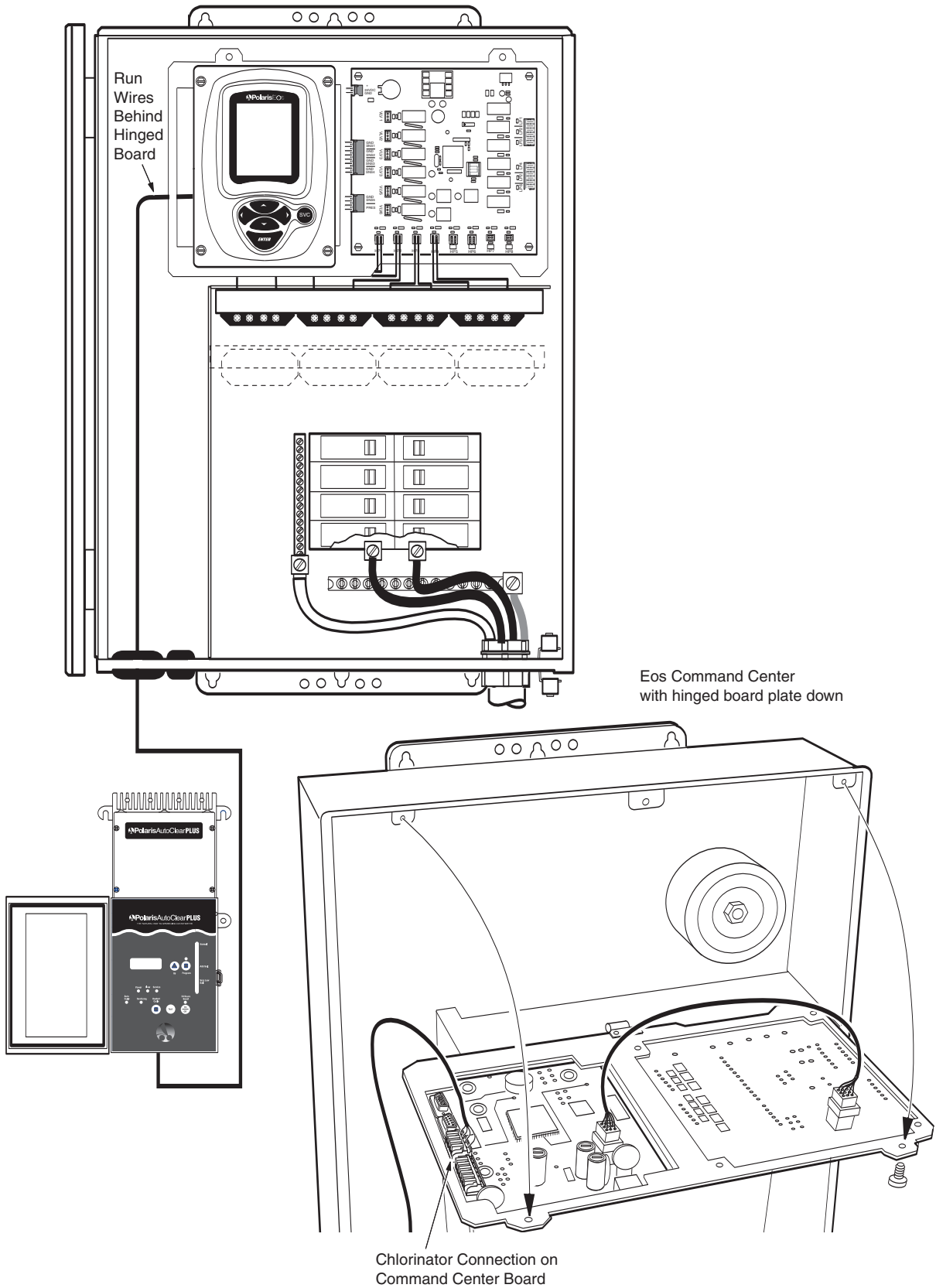

## AutoClearPLUS Salt Chlorinator (part #85-600)

In addition to the AutoClearPLUS, the Eos is compatible with Goldline AquaRite and Auto Pilot. Refer to the chlorinator owner's manual for complete installation instructions.

The AutoClearPLUS can be connected directly to Eos **or** be connected through a Polaris Watermatic C2100. Connecting directly provides remote control monitoring of the salinity levels. For automated monitoring and control of chlorination production, as well as pH control, connect the chlorinator to a C2100 that is connected to Eos.

### To connect the AutoClearPLUS directly to Eos:

**CAUTION: Verify that power is disconnected before performing any installation.**

At the AutoClearPLUS controller:

1. Remove the face plate from the controller.
2. Slide the 4-wire connector cable (sold separately) through the grommet in the base of the controller.

Connect the cable to the block on the back of the face plate with the pin/wire color sequence:

Pin #	Wire Color
1	Red
2	Black
3	Yellow (White)
4	Green

3. Verify that all connections are secure, then reattach the face plate.

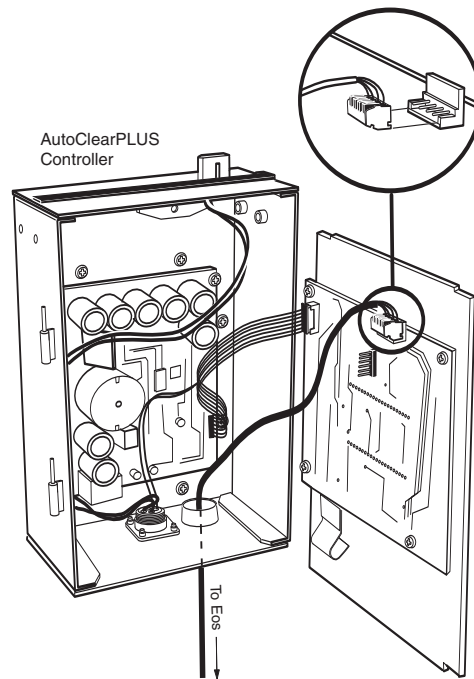

At the Eos command center:

1. Unscrew and swing down the hinged board plate to access the command center board.
2. Route the chlorinator cable through the low voltage compartment. Attach the wires to the 4-pin removable connector using the pin/wire color sequence:

Pin #	Wire Color
1	Black
2	Yellow (White)
3	Green
4	Red

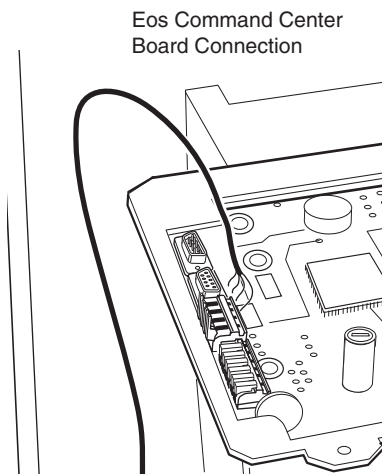



Watermatic C2100  
with door open

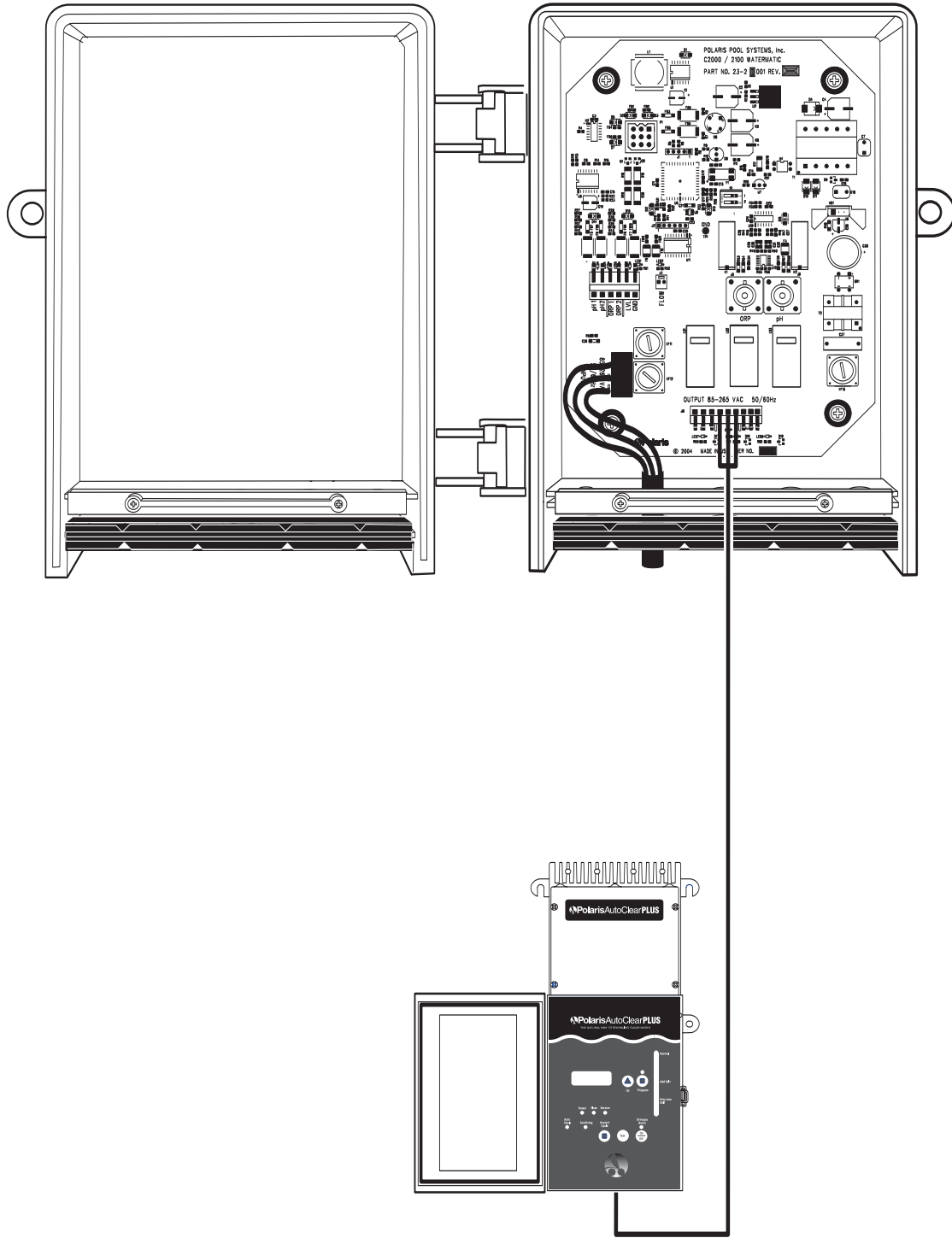

## To connect the AutoClearPLUS to a Watermatic C2100:

**CAUTION:** Verify that power is disconnected before performing any installation.



The AutoClearPLUS is shipped for 240 VAC power. In order to connect it to the C2100, it must be rewired for 120 VAC.

To rewire for 120 VAC:

1. Remove cover plate from AutoClearPLUS power supply to access the AC terminal connections.
2. Add a jumper between terminals 3 and 4.
3. Replace the 1.5 Amp fuse installed with the 3 Amp fuse included in the chlorinator spare parts bag.
4. Reinstall the plate cover.

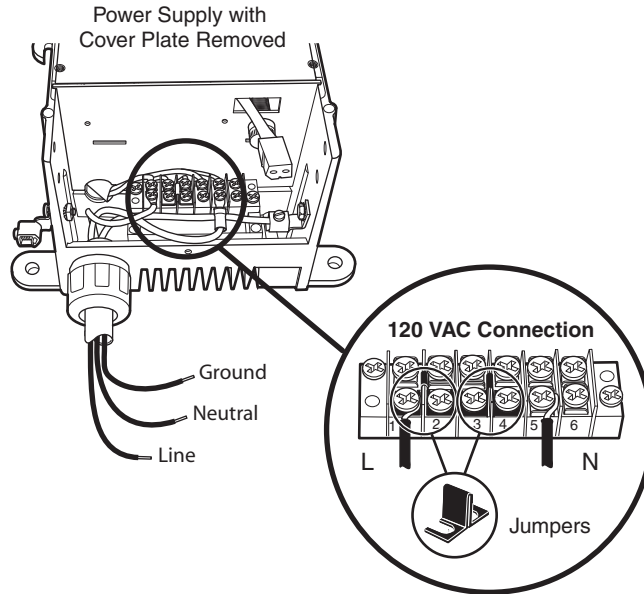

To connect to the C2100:

1. Run the AC wiring from the chlorinator to the Watermatic controller.
2. Open the controller door and connect the wiring to the ORP terminal at the bottom of the C2100 board.
3. Close and secure the door.

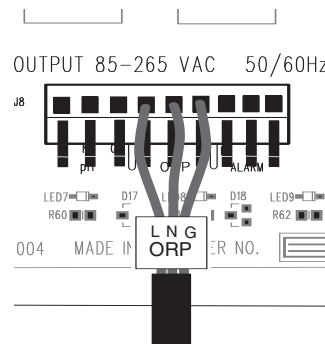

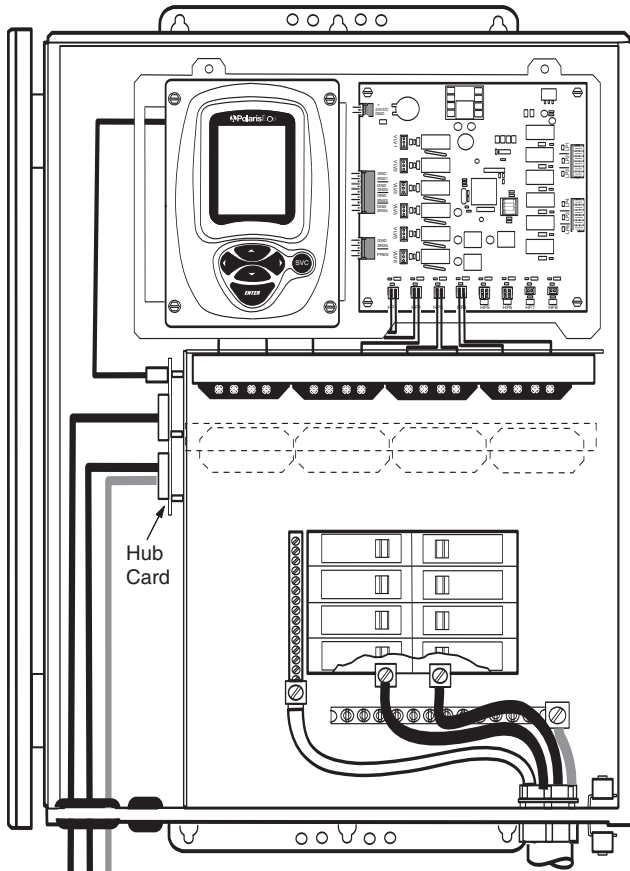

Hub Card

Eos Command Center with hinged board plate down

Wireless Antenna



Shortcut Remote



In-House Panel

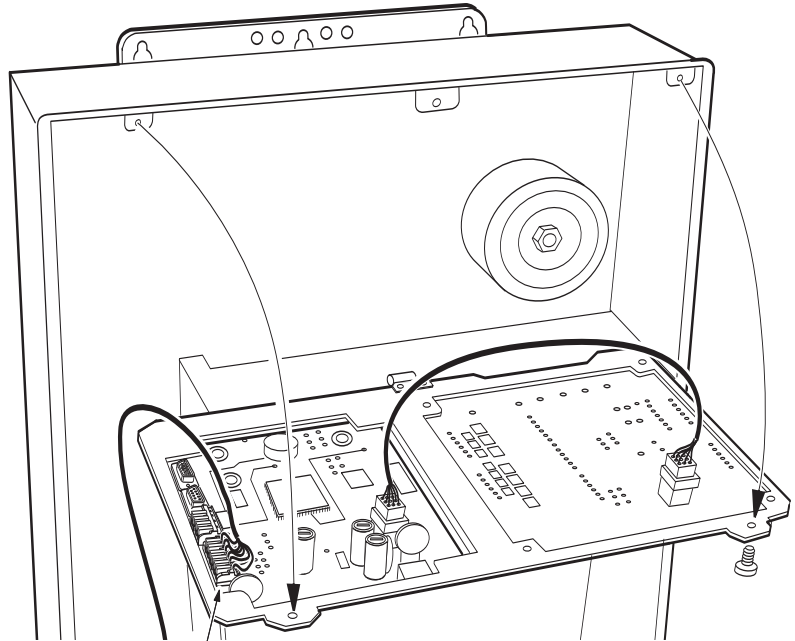

Hub Card Connection on Command Center Board

# Remote Control Options



## RBC Hub Card (part #E36)

The hub card expansion connector allows four RBC devices (In-House Panel, Wireless Antenna, Shortcut) to be connected to the Eos Command Center simultaneously. An RBC Hub Card is required when two or more remote devices are connected.

**CAUTION: Verify that power is disconnected before performing any installation or modification.**

1. Attach the hub card to the wall of the low voltage compartment in the command center using the pre-drilled holes to hold the card standoffs.

The red connector should be attached to the top of the card.

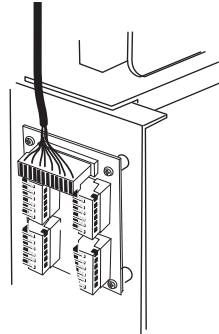

2. Connect the hub card to the 6-pin removable terminal block on the command center board.

Pin #	Wire Color
1	Green
2	Yellow
3	Orange
4	Red
5	Blue + Brown
6	Black + Purple

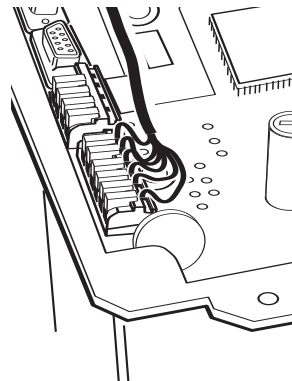

3. Wire the remote devices to the removable terminal blocks on the hub card following the pin/wire color sequence for the specific device.

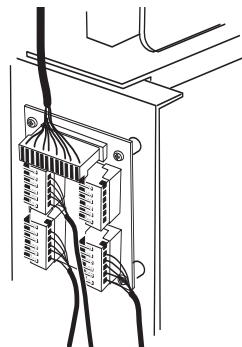

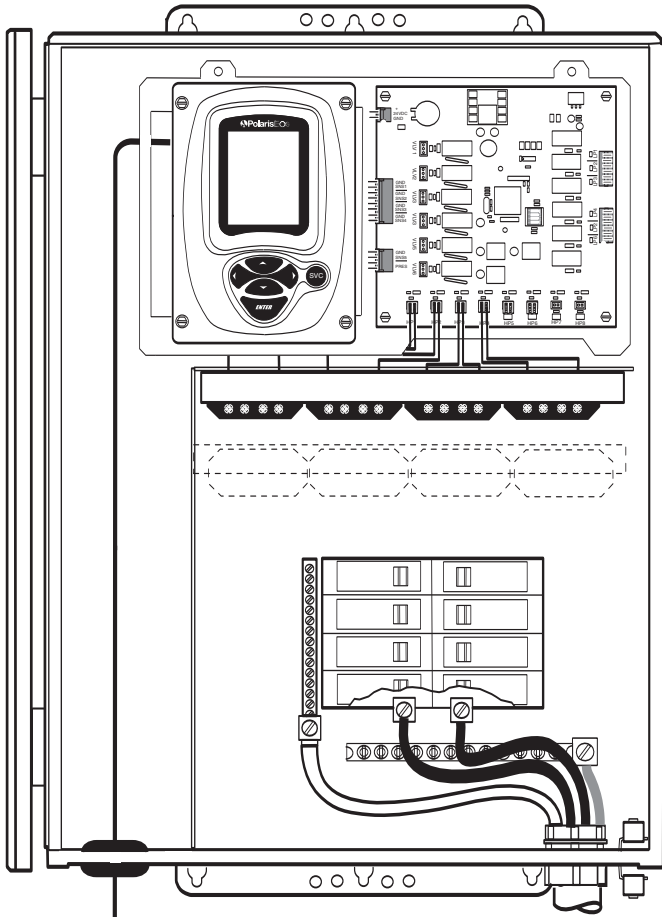

Eos Command Center  
with hinged board plate down

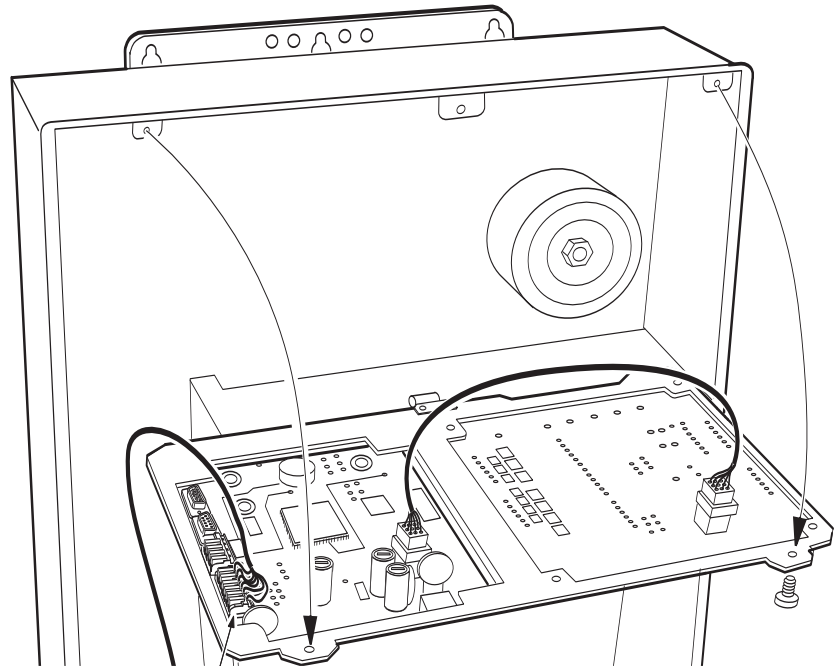
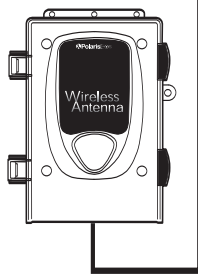

Antenna Connection on  
Command Center Board

## Wireless Remote Kit (part #E20)

### Wireless Antenna

Up to three remotes can be used with one antenna.

To ensure clear, strong communication between the command center and the Wireless Remote, determine optimum positioning for the antenna before permanently installing it.

1. Position the antenna in the center of the coverage area (shown here in gray).
2. Temporarily connect antenna to command center to test for reception.
3. Power up command center and the remote (must be fully charged). If the Setup screen displays on the remote, communication is established.
4. Walk around the coverage area, checking the remote display signal level indicator to ensure communication is present in all locations. Move antenna if necessary.

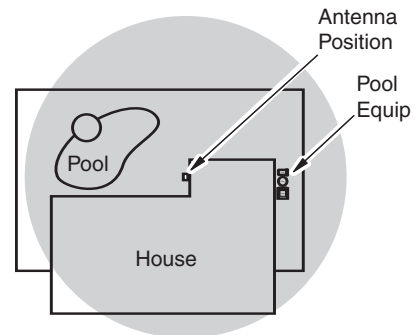

Once the optimum position is determined, the antenna should be mounted:

- In an elevated location, at least 5 feet off the ground.
- At least 6 feet away from the command center and pool equipment.
- In line-of-sight of where the wireless remote will most often be used.
- In or near the center of the coverage area.
- Away from areas where the radio signal must pass through fencing, stucco walls, reinforced block walls, etc.

**CAUTION: Verify that power is disconnected before performing any installation.**

1. Open the antenna door and connect cable wires (additional cable lengths are available, contact Polaris) to the removable terminal block using the pin/wire color sequence:

Pin #	Wire Color
1	Green
2	Yellow
3	Orange
4	Red
5	Blue + Brown
6	Black + Purple

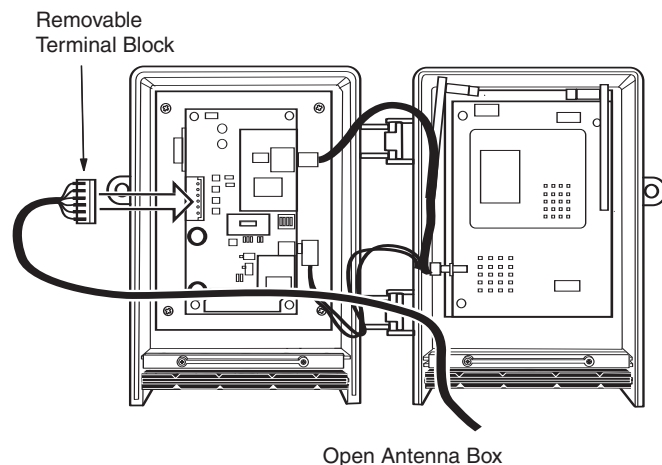

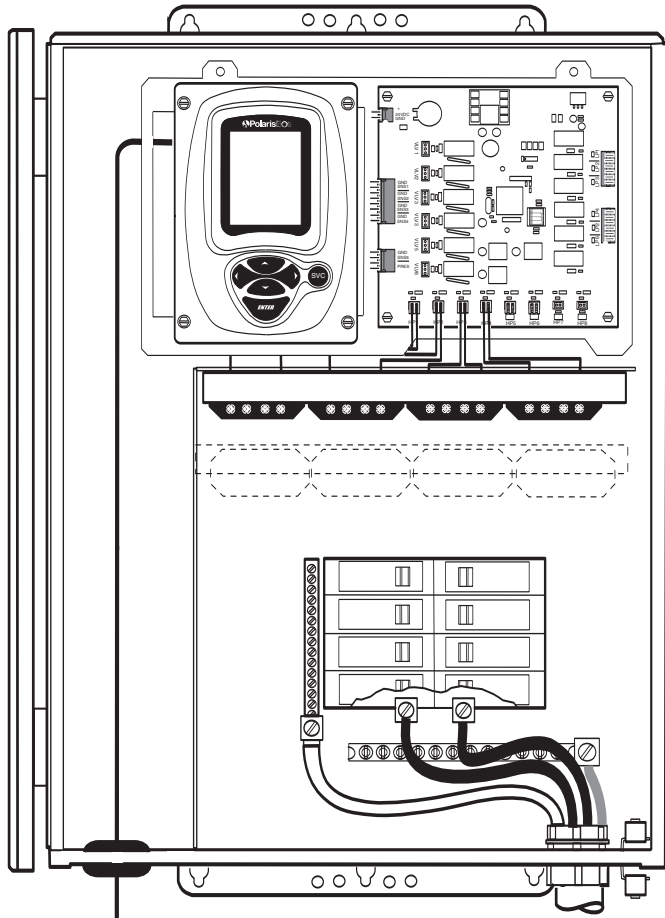

Eos Command Center  
with hinged board plate down

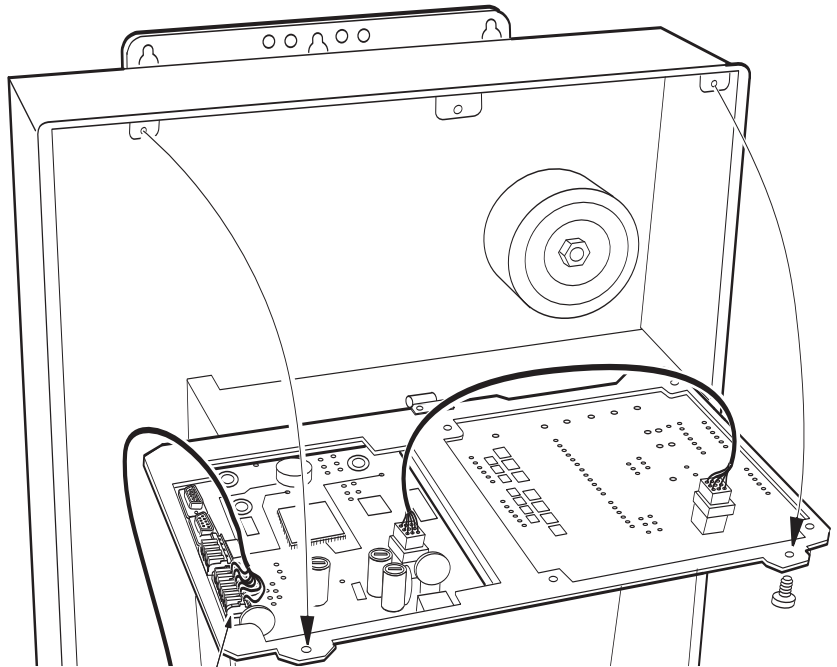
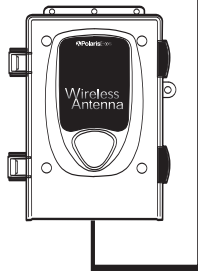

Antenna Connection on  
Command Center Board

2. Remove the wire clamp and feed the wire into the left-most position, leaving about 12" of extra cable in the box.
3. Push the wire into the rubber grommet seal. Reinstall the clamp and close the box.
4. Route the antenna cable to the command center, **do not damage the cable if securing with staples or fasteners**, and up through the low voltage compartment.
5. Connect the antenna wires to the RBC Hub Card or swing down the hinged board plate and connect to the 6-pin removable terminal on the command center board using the same pin/color sequence.

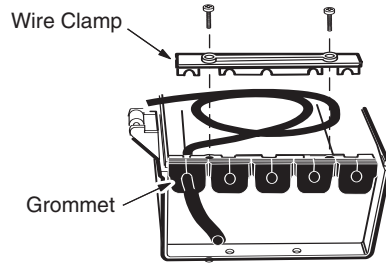

Pin #	Wire Color
1	Green
2	Yellow
3	Orange
4	Red
5	Blue + Brown
6	Black + Purple

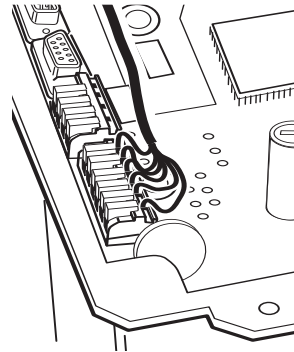

## Wireless Remote

The wireless remote uses the Polaris rechargeable Lithium ion battery (part #E33). **The battery must be charged for at least five (5) hours before use.**

- A good connection between the remote and charger is indicated by an audible chirp as the remote connects.
- An animated scrolling of the battery symbol on the remote display indicates charging.

With a full charge, the remote can operate for up to two days, depending on usage. It is normal for the battery to discharge when not in use. To ensure a full charge, always store remote on the charging base when not in use. **Battery replacement should be done by authorized Polaris service personnel only.**

Position the remote and charging base in a weather protected location, away from prolonged direct sunlight, where a strong consistent signal is received from the antenna.

1. Plug in the charging base.
2. Insert remote into base.

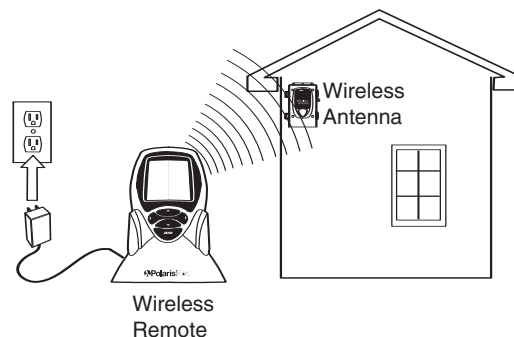

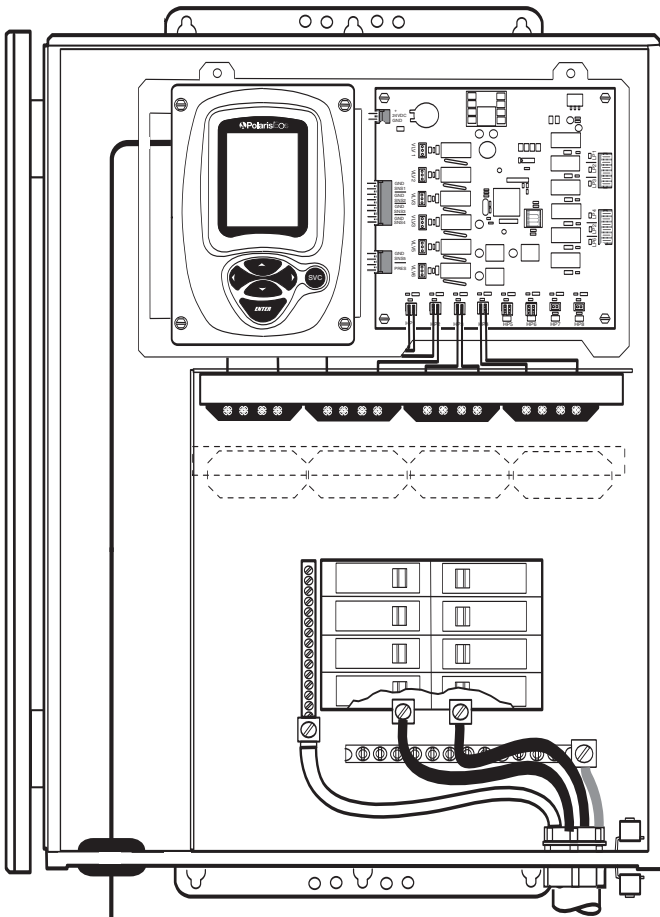

Eos Command Center with hinged board plate down

In-House Panel

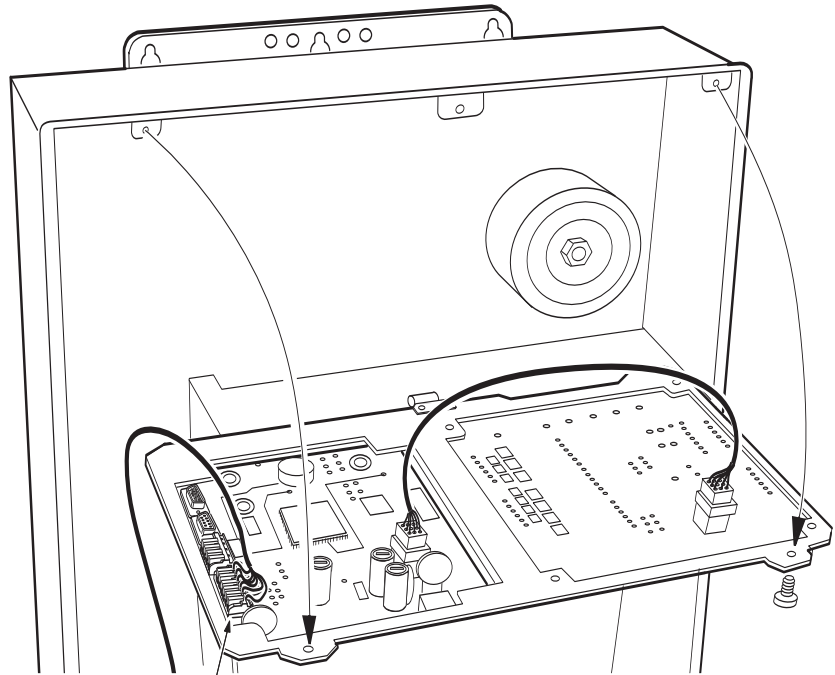

In-House Panel Connection on Command Center Board



## In-House Panel (Wired) Remote (part #E21)

Install the wired remote in a convenient location, away from prolonged direct sunlight. To connect multiple remotes, install a RBC Hub Card (part #E36).

**CAUTION: Verify that power is disconnected before performing any installation or modification.**

1. Pull the 8-wire cable through the wall and connect the wires to the 6-pin connector on the back of the wired remote using the pin/wire color sequence:

Pin #	Wire Color
1	Green
2	Yellow
3	Orange
4	Red
5	Blue + Brown
6	Black + Purple

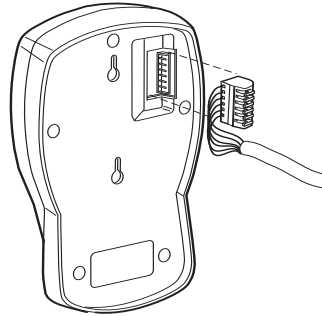

2. **If using a junction box**, install mounting screws (not included) into the center holes of the junction box. Slide wired remote onto screws.

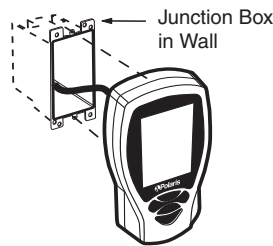

**If using a direct wall mount**, use a level and template to measure, then drill two pilot holes into the wall. Install wall anchors and screws. Slide wired remote onto screws.

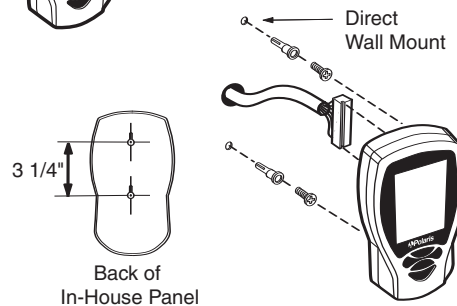

3. Pull the remote cable to the Eos Command Center and route it up through the low voltage compartment.

4. Connect the remote wires to the RBC Hub Card or swing down the hinged board plate and connect to the removable terminal on the command center board using the same pin/color sequence.

Pin #	Wire Color
1	Green
2	Yellow
3	Orange
4	Red
5	Blue + Brown
6	Black + Purple

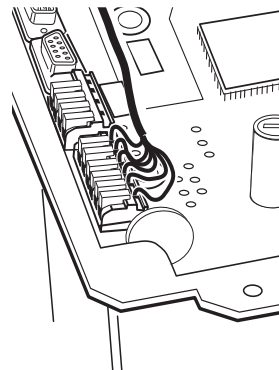



Shortcut Remote

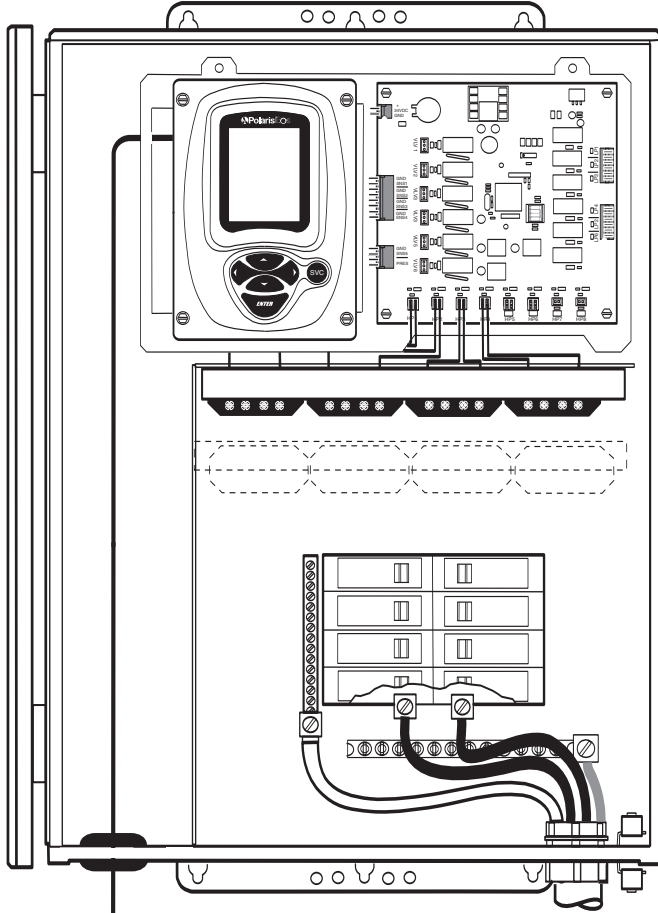

Eos Command Center  
with hinged board plate down

Shortcut Remote

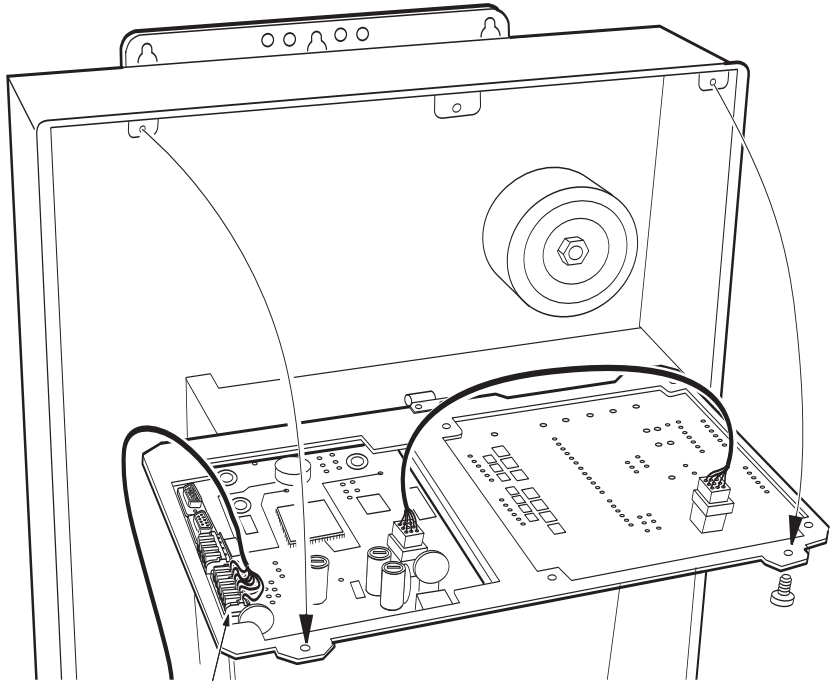

Remote Connection on  
Command Center Board

## Shortcut Remote (Part #E22, E23, E24)

The 10-function Shortcut can be installed as an in-house panel or as a spa-side remote. To connect multiple remotes, install a RBC Hub Card (part #E36).



**CAUTION: Verify that power is disconnected before performing any installation.**

1. **When mounting as a spa-side remote,** plumb a 1" or 1-1/2" dia. Sch. 40 PVC pipe to the spa wall, at least 2" below the deck level but above water level.

Install adapter bushing if 1-1/2" PVC is used.

Apply silicone sealant to all mating surfaces, including washer if used, and push remote securely into pipe.

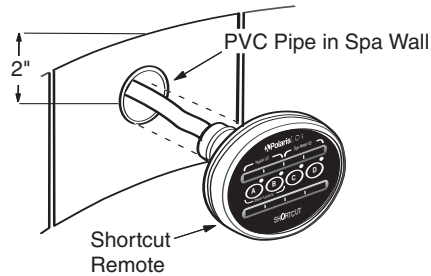

**When mounting as an in-house remote,** use the mounting bracket as a template to measure and mark holes.

Drill holes for mounting.

Pull the remote cable through the mounting bracket and secure the bracket to the wall.

Push remote securely onto bracket.

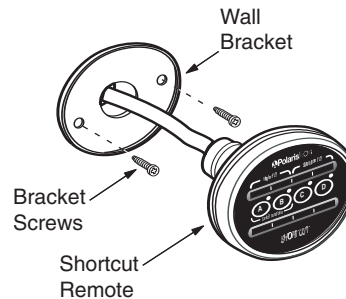

2. Pull the remote cable to the Eos Command Center and route it up through the low voltage compartment. Cut off excess cable, do not coil it inside the command center.

3. Connect the remote wires to the RBC Hub Card or swing down the hinged board plate and connect to the removable terminal on the command center board using the same pin/color sequence.

Pin #	Wire Color
1	Green
2	Yellow
3	Orange
4	Red
5	Blue
6	Black

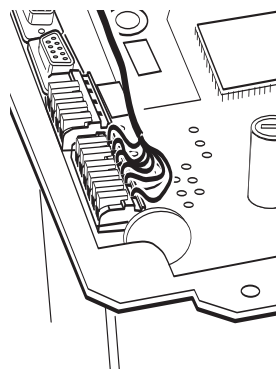

4. When the connection is complete and all equipment has been setup in the system, the remote button functions will be assigned as part of System Setup.

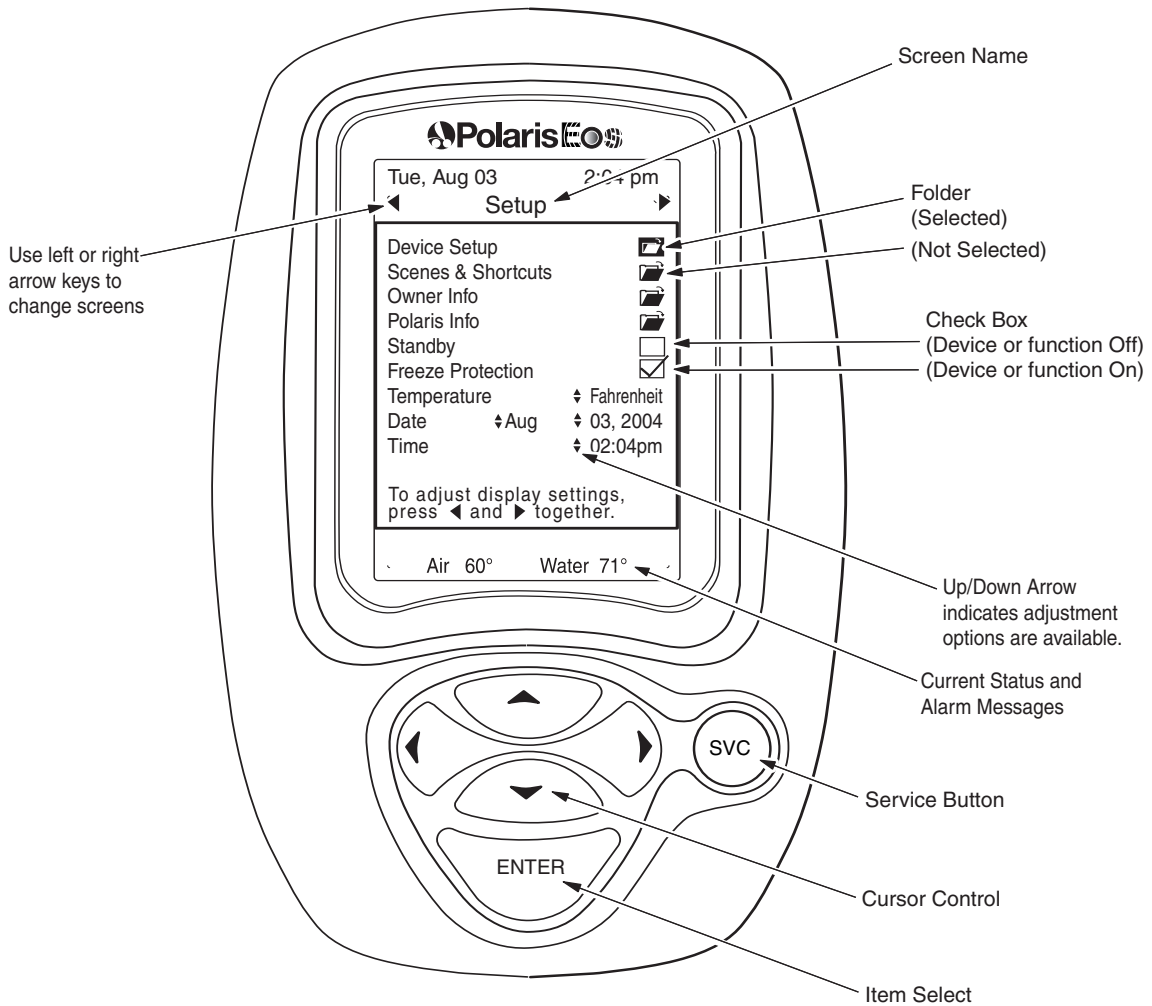

# System Setup



To establish controls and equipment schedules, at the initial startup of the Eos system:

- Get familiar with screen displays and navigation of the system
- Set the date and time
- Complete Device Setup to define and configure all equipment controlled by Eos

## 1

### Starting the Eos Command Center

**To activate:** Turn on circuit breaker to power up command center.

**To disable or put in “Standby Mode”:** Press and hold the Enter key for five seconds. Press any key to reactivate.

**To shut down:** Turn off main power source to command center.

### Command Center Display Overview

At start up, the Setup screen will appear on the command center display screen. (If a Watermatic controller or salt chlorinator is installed, the associated control screens will be displayed but they are not active until setup is complete. Use the left or right arrow keys on the keypad to move to the Setup screen.)

#### Display Symbols



Folders indicate that additional screens, menus or setup options are available for an item.



Check Boxes are used to turn functions or devices on or off. Checked = On.



Up/Down Arrow indicates adjustment options are available for the field next to it, and the up or down arrow keys are used to select or enter the setting.



Item in reverse (white text on black box) indicates cursor is over item or field.



Asterisk in front indicates a text field (blank line) that can be named by user.



Clock next to equipment status field means device is scheduled to be “on.”



Flame next to status field of heater means heater is firing.

To navigate the system for setup and operation:

- Use arrow (cursor control) keys to move through screens and menu options.
- When the cursor is over an item, it will appear darkened or in reverse (white on black instead of black on white).
- Press the Enter key to select an item.

To set or adjust an item:

1. Use keypad arrow keys to move the cursor over the item.
2. Press <Enter> to select the item. The item will flash.
3. Use the up/down keys to choose or enter the setting.
4. Press <Enter> to activate the setting.



To adjust the brightness or contrast of the display, press the left and right arrow keys simultaneously to open the Command Center Setup screen.

## Command Center Setup Screen Overview

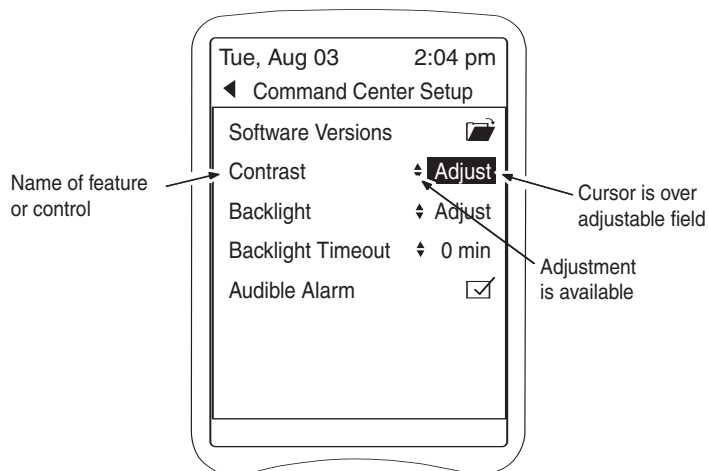

### Software Version

Not part of display adjustment controls, this screen provides information on the current software versions for the command center and the various devices it controls.

### Contrast

Controls readability of text, light or dark, on screen.

### Backlight

Controls illumination of screen for nighttime use and brightens for normal usage.

### Backlight Timeout

Sets a time limit for inactivity after which the backlight on the display turns off. Hit any key to reactivate the display. Time range is 1 min. to 10 min., 1 hour or On.

To set or adjust any of the display controls:

1. Use arrow keys to move the cursor over the field to be adjusted. (Ex: **Adjust** )
2. Press <Enter> to select. The item will flash.
3. Use up arrow to increase or down arrow to decrease screen effect until it is at desired setting.
4. Press <Enter> to activate setting.

### Audible Alarm

Activates and deactivates the alarm, **within the command center only**, that sounds when an alert condition is present. Use arrow keys to move cursor over check box and press <Enter> to check (activate) or uncheck (deactivate) the option.

When adjustments are complete, use the left arrow key to return to the **Setup** screen.

## Setup Screen Overview

At startup, the Setup screen is the only active screen. From this screen, by choosing the various folders and adjustment fields, all basic setup information is input.

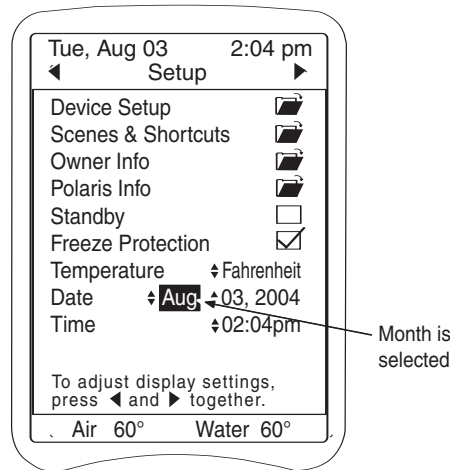

### Device Setup

Defines and configures the equipment, pumps, lights, heaters, valves, sensors, etc. that the command center will control. **Complete Device Setup first as subsequent system specifications are dependent on this configuration.**

### Scenes & Shortcuts

Establishes user-defined shortcuts that allow several devices to be started and stopped with a single command. **All system device connections and setups must be complete before Scenes or Shortcuts can be established.**

### Owner Info

Allows input of owner name and address.

### Polaris Info

Allows input of information such as serial number and service contact phone number.

#### Using Text Fields

- Move cursor over field and press <Enter> to select.
- Use the up/down arrow keys to move through the alpha-numeric options.
- Use the left/right arrow keys to move within the field.
- Press <Enter> when the entry is complete.

### Standby

Checking the box disables all automatic control functions.

### Freeze Protection

Freeze Protection should always be checked (default). If unchecked, all equipment controlled by Eos is removed from freeze protection. **Freeze Protect must also be specified for each individual device** (i.e., pumps, valves, etc.) except for the circulation pump which is covered by enabling this single setting.

### Temperature

Defines how temperatures are displayed: Fahrenheit or Celsius.



# 2

## Setting the Date and Time

It is imperative that the date and time be set correctly to ensure proper function of the equipment scheduling feature.

The command center offers multiple start and stop times and the ability to set various schedules. The built-in 365 day calendar clock accommodates multiple schedules without monthly reprogramming.

### Date

Sets the current date by month, day and two-digit year.

### Time

Sets the current time along with an am or pm designation.

To set or adjust the date:

1. Use the arrow keys to move the cursor over the month field.  
(Ex: **Aug**)
2. Press <Enter> to select the item.  
The item will flash.
3. Use the up or down arrows to select the desired setting.
4. Press <Enter> to activate the setting.
5. Use the same steps to set the day and year.

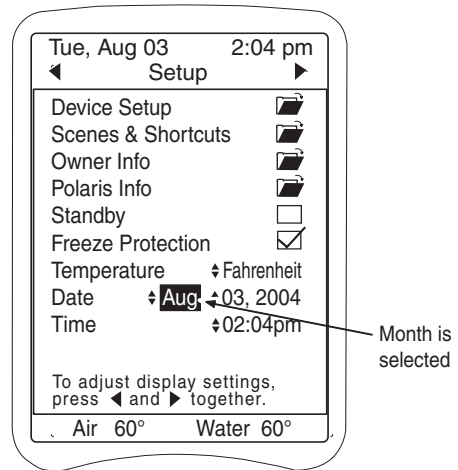

To set or adjust the time:

1. Use the arrow keys to move the cursor over the hour field  
(Ex: **02**) first.
2. Press <Enter> to select the item.  
The item will flash.
3. Use the up arrow to run through the setting options, selecting the appropriate hour with am or pm.
4. Press <Enter> to activate the setting.
5. Use same steps to set minutes.

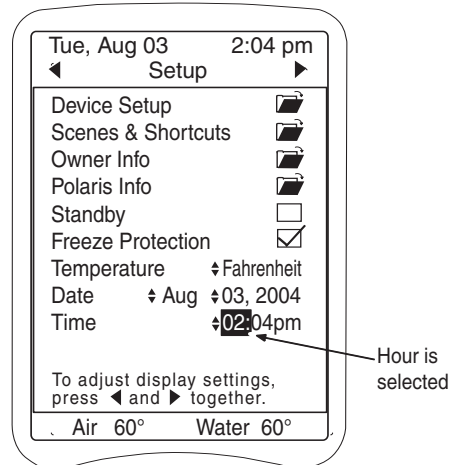

When all three fields of the date and both fields of the time are programmed, move the cursor to the Device Setup folder. Press <Enter> to open the **Device Setup** screen.

## Device Setup Screen Overview

From the Device Setup screen the system configuration is established and the devices to be controlled by the command center are defined.

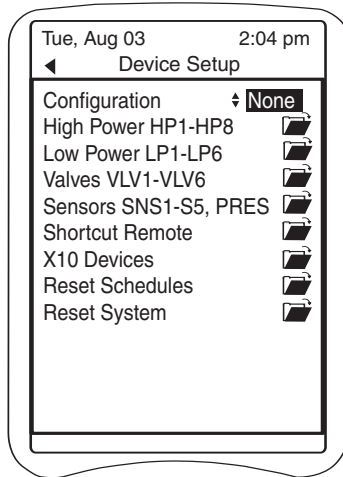

### Configuration

The Eos system can be used with any pool/spa combination. Device Setup specifications vary depending on the configuration of the installation. For example: suction and return valve options are not available for a Pool Only configuration but are available on the Combo configuration.

The configuration options available on Device Setup are:

Configuration Option	Installation Type
Combo	Pool and Spa combination, shared plumbing
Pool Only	Pool only
Spa Only	Spa only
Separate	Pool and spa installations that are plumbed separately
None	Eos controls auxiliary equipment (landscape lighting, ceiling fans, etc.) only.

### High Power HP1-HP8 Low Power LP1-LP6 Valves VLV1-VLV6 Sensors SNS1-5, PRES

The individual device setup screens (accessed by the folders) are where equipment is selected or named, and assigned to its specific connection location. Devices are categorized just as they were in installation i.e., High Power, Low Power, etc.

### Shortcut Remote

The Shortcut remote is one of three options for remotely controlling Eos equipment (pump, light, heater, etc.). **All devices must be set up first to make the Shortcut functions available.** Setup instructions for the Shortcut and the other remote options are in the **Remote Setup** section.



## PLC (X-10) Devices

PLC devices are named and assigned on a separate device screen where house codes and device codes are established for each PLC Receiver.

### Reset Schedules

Clears all device schedules. A confirmation screen will verify this selection before initiating the change. Select Yes and press <Enter> to activate reset. **CAUTION: There is no retrieval of deleted schedules.**

### Reset System

Clears all system settings: HP Setup, LP Setup, etc. A confirmation screen will verify this selection before initiating the change. Select Yes and press <Enter> to activate reset. **CAUTION: There is no retrieval of the deleted configurations.**

# 3

## Completing Device Setup

To start the setup procedure, select the configuration:

1. Use arrow keys to move the cursor over the adjustable field. (Ex: **None**)
2. Press <Enter> to select the item. The item will flash.
3. Use the up or down arrow to select the desired configuration.
4. Press <Enter> to activate the setting.
5. A confirmation screen will appear. Move cursor to Yes and press <Enter> to activate the selection.

The Device Setup screen will change to reflect the chosen configuration.

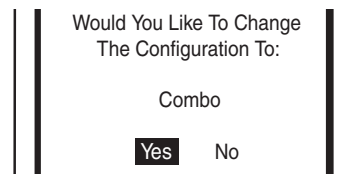
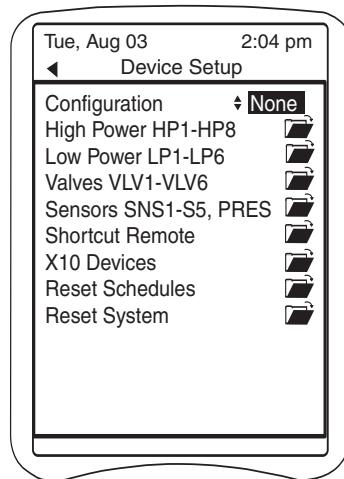

Device Setup instructions are presented for each specific configuration. Refer to the appropriate section to continue setup:

**Device Setup - Configuration Combo**, page 55.

**Device Setup - Configuration Pool Only**, page 61.

**Device Setup - Configuration Spa Only**, page 67.

**Device Setup - Configuration Separate**, page 73.

For applications where only auxiliary devices are installed, follow any of the setup configurations to become familiar with programming the devices.

## Device Setup - Configuration Combo

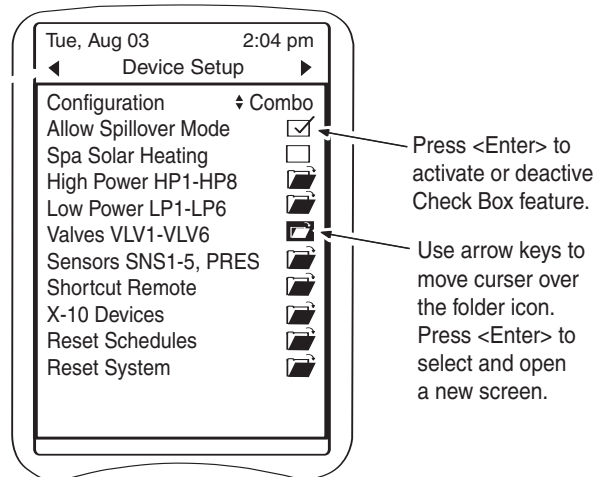

### Allow Spillover Mode

By factory default, this check box is enabled (checked) and the spa spillover, “Spill,” option is available in Circulation Mode (see **Main Screen Overview**). During “Spill” mode, water is pulled from the pool and returned to the spa only, forcing water to spill back into the pool for a dramatic effect.

If the spa is separated from the pool and an equalizer line maintains the water level, this feature should be disabled.

### Spa Solar Heating

When activated (checked), the feature allows solar heating for both the pool and spa. The default is unchecked. Solar heating operates only when the solar sensor reads 5 degrees warmer than the water temperature.

### Device Screen Overview

The device screens (High Power HP1-HP8, Low Power LP1-LP6, Valves VLV1-VLV6 and Sensors SNS1-5, PRES) provide the means for defining the equipment that is connected to the command center.

Each device screen provides:

- Activator board position name. (Ex: HP1)
- Device name field. (Ex: **None**)  
Device lists are available when field is selected.
- Check box (except Sensors that have a calibration function).  
Checking the box activates the device connected at that position. Use to identify/verify device connections.
- Connection assignments for Activator #2, #3 and #4 (used if Extension Panels are installed) are accessed by moving the cursor to “More.”

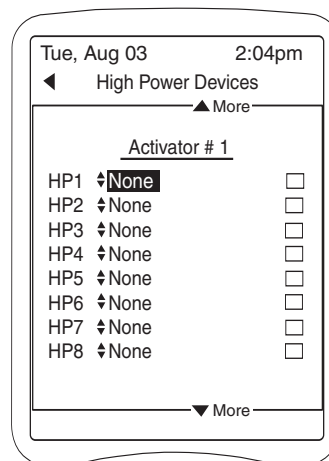



General rules for device assignments:

- **Device assignments must match the device's physical connection position** on the command center activator board.
- **Do not unplug devices from the activator board while the Eos is powered.**
- Some device options cannot be duplicated. If two or more devices need to change assignments, change them back to "None" and then reassign.
- Some devices, such as a dimmer, offer custom naming to distinguish multiple units or to personalize the device. These devices are displayed with an asterisk in front of the device name.

**User Defined** is an option for naming devices not included on the device lists. This option provides no equipment associations (see **Device Associations**).

#### Using Nameable Text Fields

- Move cursor over name field and press <Enter> to select. The last letter of the name will blink.
- Use the left arrow key to erase the item name.
- Use the up/down arrow keys to access the alpha-numeric options.
- Use the right arrow key to move to the next letter.
- Press <Enter> when the entry is complete.

To change the item back to "None," move to the asterisk and press <Enter>.

## High Power HP1-HP8

Defines the high power (120/240 VAC) devices controlled by the Eos and assigns them to their activator board connection positions.

General rules for HP device assignments:

- If the circulation pump is two-speed, identify the standard relay as the circulation pump and the 2-speed relay as low speed.
- If a fiber optic light driver is installed, identify the light driver as Fiber Optic and the color wheel as Color Wheel.
- If a dimmer is installed, select Dimmer and then rename the device to identify the light being dimmed (Ex: Spa Light Dim). Dimming capability is from 0 to 100%, in increments of 10.

To assign or reassign an HP device:

1. Move the cursor over the High Power HP1-HP8 folder and press <Enter> to open the **High Power Devices** screen.
2. Move the cursor over the activator position to be assigned. (Ex: HP1)
3. Press <Enter> to select the item. The item will flash.

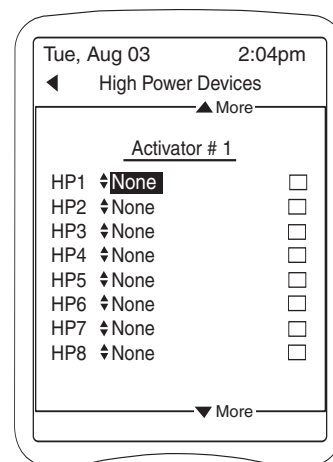



- Use the up/down arrow keys to access the HP device options.

<b>Combo HP Device Options</b>	<b>Description</b>
PS Circ Pump	Shared Pool & Spa Circulation Pump
PS Low Speed	Shared Low Speed Pool & Spa Circulation Pump
PS Heater	Shared Pool & Spa Heater
Pool Heater	Pool Only Heater
Spa Heater	Spa Only Heater
PS Heat Pump	Shared Pool & Spa Heat Pump
Pool Heat Pump	Pool Only Heat Pump
Spa Heat Pump	Spa Only Heat Pump
Pool Chiller	Pool Only Chiller
Solar Pump	Solar Booster Pump
Cleaner Pump	Pressure Cleaner Booster Pump
Spa Jet Pump	HydroTherapy Jet Pump
Blower	Air Blower
Waterfall	Waterfall Pump
Water Feature	Waterfall Pump
PS Lighting	Shared Pool & Spa lights
Pool Light	Pool Only Light
Spa Light	Spa Only Light
Fiber Optic	Fiber Optic Light Driver
Color Wheel	Color Wheel for Light Driver
Lights	Accessory Lights
Dimmer	Nameable Pool or Spa Lights on Dimmer Relay
User Defined	Nameable Auxiliary Devices

- Select the device connected to the HP position and press <Enter> to activate the selection.
- Use the arrow keys to move to the next HP position assignment and repeat these steps until all HP devices are assigned.

When all assignments are complete, use the left arrow key to return to the **Device Setup** screen.

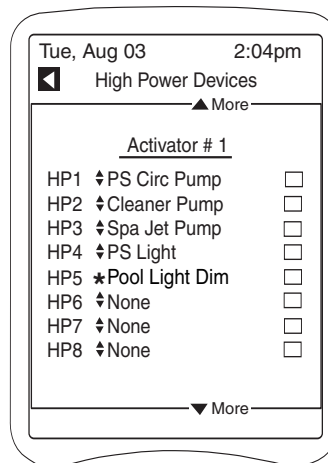



## Low Power LP1-LP6

Defines the low power devices controlled by Eos.

General rules for LP device assignments:

- If using multiple heaters, use the rename option to simplify identification.  
(Ex: Heater 1 and Heater 2, or Raypak and AquaCal)

To assign or reassign a LP device:

1. Move the cursor over the Low Power LP1-LP6 folder and press <Enter> to open the **Low Power Devices** screen.
2. Move the cursor over the activator position to be assigned. (Ex: LP1)
3. Press <Enter> to select the item. The item will flash.
4. Use the up/down arrow keys to access the LP device options.

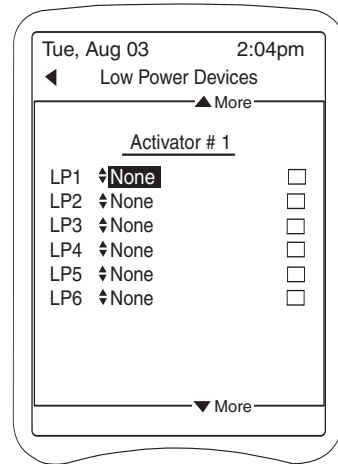

### Combo

LP Device Options	Description
PS Heater	Shared Pool & Spa Heater
Pool Heater	Pool Only Heater
Spa Heater	Spa Only Heater
PS Heat Pump	Shared Pool & Spa Heat Pump
Pool Heat Pump	Pool Only Heat Pump
Spa Heat Pump	Spa Only Heat Pump
Pool Chiller	Pool Only Chiller
LS Lighting	Landscape Lighting
User Defined	Nameable Auxiliary Devices

5. Select the device connected to the LP position and press <Enter> to activate the selection.
6. Use the arrow keys to move to the next LP position assignment and repeat these steps until all LP devices are assigned.

When all assignments are complete, use left the arrow key to return to the **Device Setup** screen.

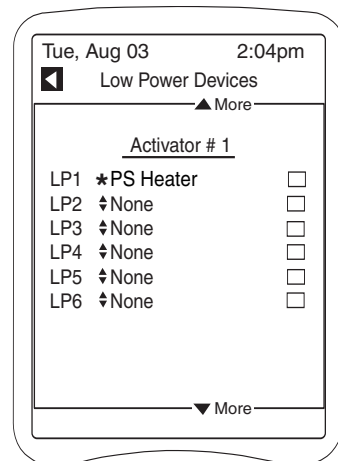



## Valves VLV1-VLV6

Defines the valve actuators connected to Eos.

General rules for valve assignments:

- Assign the suction valve and return valve separately.

To assign or reassign valves:

1. Move the cursor over the Valves VLV1-VLV6 folder and press <Enter> to open the **Valves** screen.
2. Move the cursor over the activator position to be assigned. (Ex: VLV1)
3. Press <Enter> to select the item. The item will flash.
4. Use the up/down arrow keys to access the valve options.

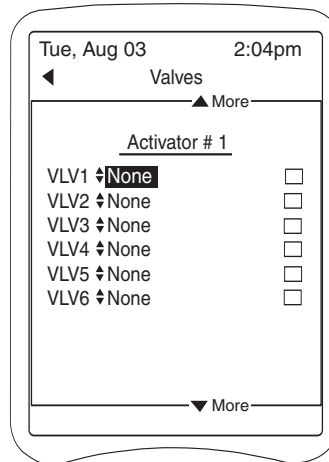

### Combo

#### Valve Options

#### Description

Solar Valve	Solar Valve Actuator
Cleaner Valve	Cleaner Valve Actuator
Suction Valve	Combo Suction Valve Actuator
Return Valve	Combo Return Valve Actuator
Spa Dep Valve	Nameable Spa Dependent Valve Actuator
Backwash Supply	Backwash Supply Actuator
Backwash Drain	Backwash Drain Actuator
Feature Valve	Water Feature Valve Actuator
Waterfall Valve	Waterfall Valve Actuator
Infloor Valve	Infloor Control Valve Actuator
User Defined	Nameable Auxiliary Valve Actuator

5. Select the device connected to the valve position and press <Enter> to activate the selection.
6. Use the arrow keys to move to the next VLV position assignment and repeat these steps until all valves are assigned.

When all assignments are complete, Use left the arrow key to return to the **Device Setup** screen.

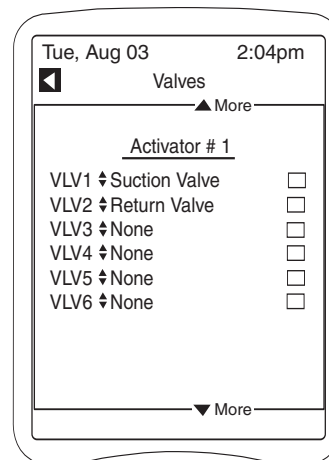



## Sensors SNS1-SNS6

Defines the sensors controlled by the Eos.

There are five possible temperature sensors and one pressure sensor. One air and one water sensor (PS Sensor) are included. The sensors can be calibrated +/- 9°.

To assign or reassign a sensor:

1. Move the cursor over the Sensors SNS1-5, PRES folder and press <Enter> to open the **Sensors** screen.
2. Move the cursor over the activator position to be assigned. (Ex: SNS1)
3. Press <Enter> to select the item. The item will flash.
4. Use the up/down arrow keys to access the sensor options.

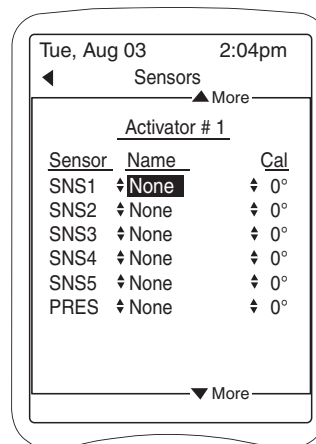

### Combo

#### Sensor Options

#### Description

Air Sensor	Air Only Temp Sensor
PS Sensor	Shared Pool & Spa Heaters Temp Sensor
Pool Sensor	Pool Heater Only Temp Sensor
Spa Sensor	Spa Heater Only Temp Sensor
Solar Sensor	Solar Only Temp Sensor
User Defined	Nameable Temp Sensor

5. Select the device connected to the sensor position and press <Enter> to activate the selection.
6. Use the right arrow key to move to the calibration (Cal) setting and adjust if desired. **CAUTION: Do not exceed high temperature recommendations.**
7. Use the arrow keys to move to the next SNS position assignment and repeat these steps until all sensors are assigned.

When all assignments are complete, use the left arrow to return to the **Device Setup** screen.

Use down arrow key to move to the X-10 Devices folder to continue device setup or use the left arrow to return to the Setup screen and then the right arrow to move to the **Main Screen**.

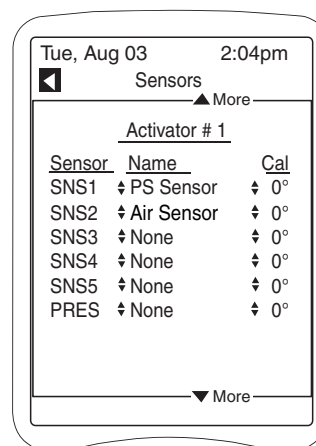

# Device Setup - Configuration Pool Only

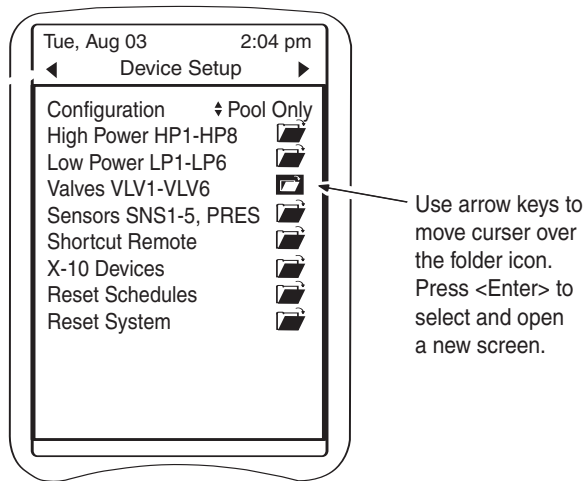

## Device Screen Overview

The device screens (High Power HP1-HP8, Low Power LP1-LP6, Valves VLV1-VLV6 and Sensors SNS1-5, PRES) provide the means for defining the equipment that is connected to the command center.

Each device screen provides:

- Activator board position name. (Ex: HP1)
- Device name field. (Ex: **None** )  
Device lists are available when field is selected.
- Check box (except Sensors that have a calibration function).  
Checking the box activates the device connected at that position. Use to identify/verify device connections.
- Connection assignments for Activator #2, #3 and #4 (used if Extension Panels are installed) are accessed by moving the cursor to "More."

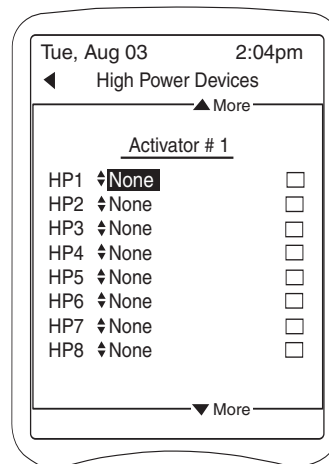

General rules for device assignments:

- **Device assignments must match the device's physical connection position** on the command center activator board.
- **Do not unplug devices from the activator board while the Eos is powered.**
- Some device options cannot be duplicated. If two or more devices need to change assignments, change them back to "None" and then reassign.



- Some devices, such as a dimmer, offer custom naming to distinguish multiple units or to personalize the device. These devices are displayed with an asterisk in front of the device name.

**User Defined** is an option for naming devices not included on the device lists. This option provides no equipment associations (see **Device Associations**).

#### Using Nameable Text Fields

- Move cursor over name field and press <Enter> to select. The last letter of the name will blink.
- Use the left arrow key to erase the item name.
- Use the up/down arrow keys to access the alpha-numeric options.
- Use the right arrow key to move to the next letter.
- Press <Enter> when the entry is complete.

To change the item back to “None,” move to the asterisk and press <Enter>.

## High Power HP1-HP8

Defines the high power (120/240 VAC) devices controlled by the Eos and assigns them to their activator board connection positions.

General rules for HP device assignments:

- If the circulation pump is two-speed, identify the standard relay as the circulation pump and the 2-speed relay as low speed.
- If a fiber optic light driver is installed, identify the light driver as Fiber Optic and the color wheel as Color Wheel.
- If a dimmer is installed, select Dimmer and then rename the device to identify the light being dimmed (Ex: Spa Light Dim). Dimming capability is from 0 to 100%, in increments of 10.

To assign or reassign an HP device:

1. Move the cursor over the High Power HP1-HP8 folder and press <Enter> to open the High Power Devices screen.
2. Move the cursor over the activator position to be assigned. (Ex: HP1)
3. Press <Enter> to select the item. The item will flash.

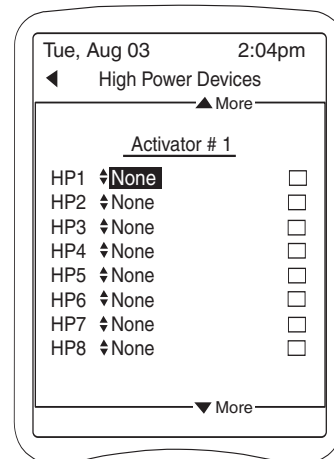



- Use the up/down arrow keys to access the HP device options.

**Pool Only  
HP Device Options**

**Description**

Pool Circ Pump	Pool Circulation Pump
Pool Low Speed	Low Speed Pool Circulation Pump
Pool Heater	Pool Only Heater
Pool Heat Pump	Pool Only Heat Pump
Pool Chiller	Pool Only Chiller
Solar Pump	Solar Booster Pump
Cleaner Pump	Pressure Cleaner Booster Pump
Waterfall	Waterfall Pump
Water Feature	Waterfall Pump
Pool Light	Pool Only Light
Fiber Optic	Fiber Optic Light Driver
Color Wheel	Color Wheel for Light Driver
Lights	Accessory Lights
Dimmer	Nameable Pool or Spa Lights on Dimmer Relay
User Defined	Nameable Auxiliary Devices

- Select the device connected to the HP position and press <Enter> to activate the selection.

- Use the arrow keys to move to the next HP position assignment and repeat these steps until all HP devices are assigned.

When all assignments are complete, use left the arrow key to return to the **Device Setup** screen.

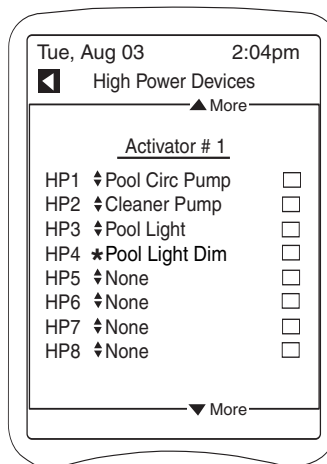



## Low Power LP1-LP6

Defines the low power devices controlled by Eos.

General rules for LP device assignments:

- If using multiple heaters, use the rename option to simplify identification. (Ex: Heater 1 and Heater 2, or Raypak and AquaCal)

To assign or reassign a LP device:

1. Move the cursor over the Low Power LP1-LP6 folder and press <Enter> to open the **Low Power Devices** screen.
2. Move the cursor over the activator position to be assigned. (Ex: LP1)
3. Press <Enter> to select the item. The item will flash.
4. Use the up/down arrow keys to access the LP Device options.

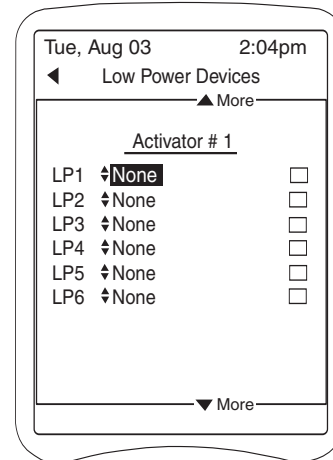

### Pool Only

LP Device Options	Description
Pool Heater	Pool Only Heater
Pool Heat Pump	Pool Only Heat Pump
Pool Chiller	Pool Only Chiller
LS Lighting	Landscape Lighting
User Defined	Nameable Auxiliary Devices

5. Select the device connected to the LP position and press <Enter> to activate the selection.
6. Use the arrow keys to move to the next LP position assignment and repeat these steps until all LP devices are assigned.

When all assignments are complete, use left the arrow key to return to the **Device Setup** screen.

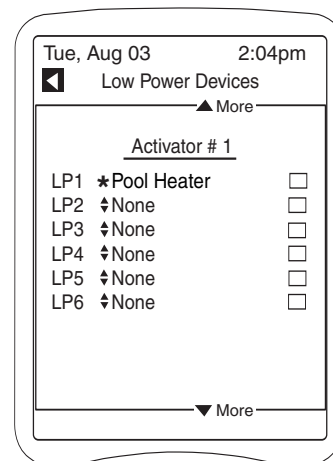

## Valves VLV1-VLV6

Defines the valve actuators connected to Eos.

General rules for valve assignments:

- Assign the suction valve and return valve separately.

To assign or reassign valves:

1. Move the cursor over the Valves VLV1-VLV6 folder and press <Enter> to open the **Valves** screen.
2. Move the cursor over the activator position to be assigned. (Ex: VLV1)
3. Press <Enter> to select the item. The item will flash.
4. Use the up/down arrow keys to access the valve options.

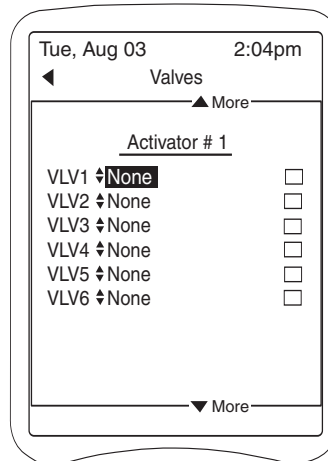

### Pool Only

#### Valve Options

#### Description

Solar Valve	Solar Valve Actuator
Cleaner Valve	Cleaner Valve Actuator
Backwash Supply	Backwash Supply Actuator
Backwash Drain	Backwash Drain Actuator
Feature Valve	Water Feature Valve Actuator
Waterfall Valve	Waterfall Valve Actuator
Infloor Valve	Infloor Control Valve Actuator
User Defined	Nameable Auxiliary Valve Actuator

5. Select the device connected to the valve position and press <Enter> to activate the selection.
6. Use the arrow keys to move to the next VLV position assignment and repeat these steps until all valves are assigned.

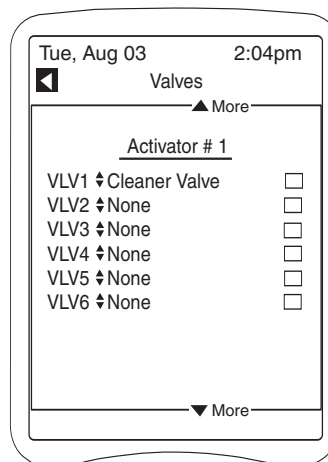

When all assignments are complete, Use left the arrow key to return to the **Device Setup** screen.



## Sensors SNS1-SNS6

Defines the sensors controlled by Eos.

There are five possible temperature sensors and one pressure sensor. One air and one water sensor (PS Sensor) are included. The sensors can be calibrated +/- 9°.

To assign or reassign a sensor:

1. Move the cursor over the Sensors SNS1-5, PRES folder and press <Enter> to open the **Sensors** screen.
2. Move the cursor over the activator position to be assigned. (Ex: SNS1)
3. Press <Enter> to select the item. The item will flash.
4. Use the up/down arrow keys to access the sensor options.

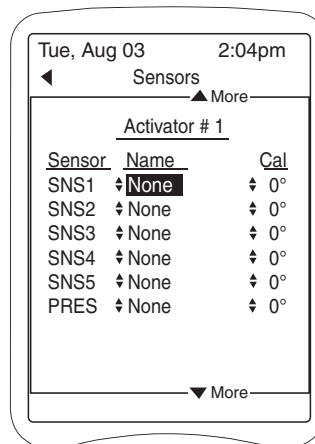

### Pool Only

#### Sensor Options

#### Description

Air Sensor	Air Only Temp Sensor
Pool Sensor	Pool Only Temp Sensor
Solar Sensor	Solar Only Temp Sensor
User Defined	Nameable Temp Sensor

5. Select the device connected to the sensor position and press <Enter> to activate the selection.
6. Use the right arrow key to move to the calibration (Cal) setting and adjust if desired. **CAUTION: Do not exceed high temperature recommendations.**
7. Use the arrow keys to move to the next SNS position assignment and repeat these steps until all sensors are assigned.

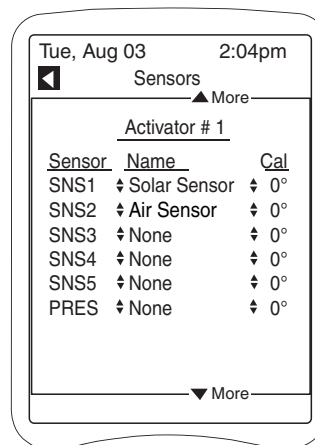

When all assignments are complete, use the left arrow key to return to the **Device Setup** screen.

Use down arrow key to move to the X-10 Devices folder to continue device setup or use the left arrow to return to the Setup screen and then the right arrow to move to the **Main Screen**.

# Device Setup - Configuration Spa Only

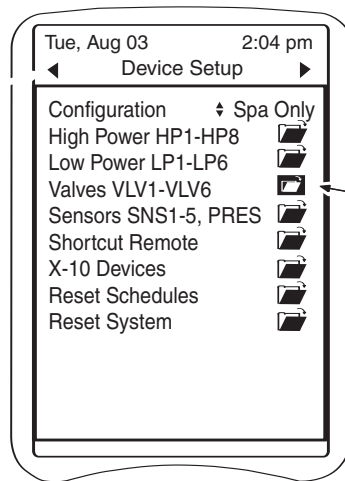

Use arrow keys to move cursor over the folder icon. Press <Enter> to select and open a new screen.

## Device Screen Overview

The device screens (High Power HP1-HP8, Low Power LP1-LP6, Valves VLV1-VLV6 and Sensors SNS1-5, PRES) provide the means for defining the equipment that is connected to the command center.

Each device screen provides:

- Activator board position name. (Ex: HP1)
- Device name field. (Ex: **None**)  
Device lists are available when field is selected.
- Check box (except Sensors that have a calibration function).  
Checking the box activates the device connected at that position. Use to identify/verify device connections.
- Connection assignments for Activator #2, #3 and #4 (used if Extension Panels are installed) are accessed by moving the cursor to "More."

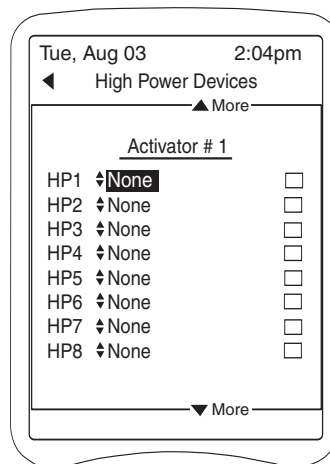

General rules for device assignments:

- **Device assignments must match the device's physical connection position** on the command center activator board.
- **Do not unplug devices from the activator board while the Eos is powered.**
- Some device options cannot be duplicated. If two or more devices need to change assignments, change them back to "None" and then reassign.



- Some devices, such as a dimmer, require input of a custom name. Others offer custom naming to distinguish multiple units or to personalize the device. These devices are displayed with an asterisk in front of the device name.

**User Defined** is an option for naming devices not included on the device lists. This option provides no equipment associations (see **Device Associations**).

#### Using Nameable Text Fields

- Move cursor over name field and press <Enter> to select. The last letter of the name will blink.
- Use the left arrow key to erase the item name.
- Use the up/down arrow keys to access the alpha-numeric options.
- Use the right arrow key to move to the next letter.
- Press <Enter> when the entry is complete.

To change the item back to “None,” move to the asterisk and press <Enter>.

## High Power HP1-HP8

Defines the high power (120/240 VAC) devices controlled by the Eos and assigns them to their activator board connection positions.

General rules for HP device assignments:

- If the circulation pump is two-speed, identify the standard relay as the circulation pump and the 2-speed relay as low speed.
- If a fiber optic light driver is installed, identify the light driver as Fiber Optic and the color wheel as Color Wheel.
- If a dimmer is installed, select Dimmer and then rename the device to identify the light being dimmed (Ex: Spa Light Dim). Dimming capability is from 0 to 100%, in increments of 10.

To assign or reassign an HP device:

1. Move the cursor over the High Power HP1-HP8 folder and press <Enter> to open the **High Power Devices** screen.
2. Move the cursor over the activator position to be assigned. (Ex: HP1)
3. Press <Enter> to select the item. The item will flash.

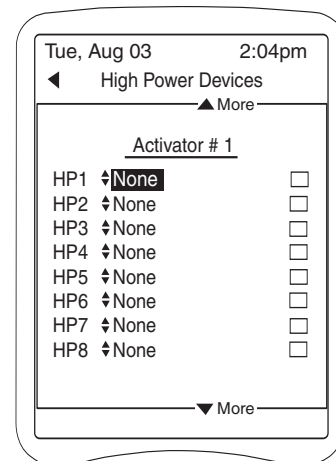



- Use the up/down arrow keys to access the HP device options.

<b>Spa Only HP Device Options</b>	<b>Description</b>
Spa Circ Pump	Spa Circulation Pump
Spa Low Speed	Low Speed Spa Circulation Pump
Spa Heater	Spa Only Heater
Spa Heat Pump	Spa Only Heat Pump
Solar Pump	Solar Booster Pump
Spa Jet Pump	Hydro Therapy Jet Pump
Blower	Air Blower
Waterfall	Waterfall Pump
Water Feature	Waterfall Pump
Spa Light	Spa Only Light
Fiber Optic	Fiber Optic Light Driver
Color Wheel	Color Wheel for Light Driver
Lights	Accessory Lights
Dimmer	Nameable Pool or Spa Lights on Dimmer Relay
User Defined	Nameable Auxiliary Devices

- Select the device connected to the HP position and press <Enter> to activate the selection.

- Use the arrow keys to move to the next HP position assignment and repeat these steps until all HP devices are assigned.

When all assignments are complete, use left the arrow key to return to the **Device Setup** screen.

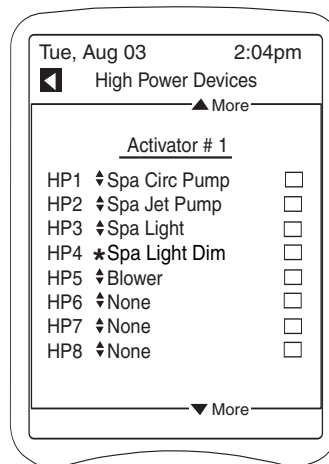



## Low Power LP1-LP6

Defines the low power devices controlled by Eos.

General rules for LP device assignments:

- If using multiple heaters, use the rename option to simplify identification. (Ex: Heater 1 and Heater 2, or Raypak and AquaCal)

To assign or reassign a LP device:

1. Move the cursor over the Low Power LP1-LP6 folder and press <Enter> to open the **Low Power Devices** screen.
2. Move the cursor over the activator position to be assigned. (Ex: LP1)
3. Press <Enter> to select the item. The item will flash.
4. Use the up/down arrow keys to access the LP device options.

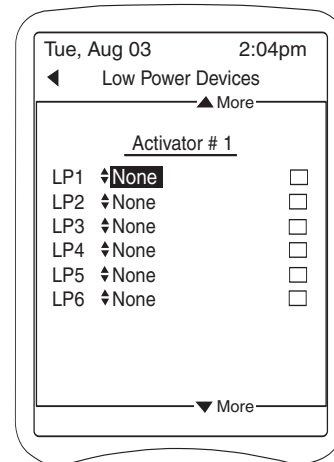

### Spa Only

LP Device Name	Description
Spa Heater	Spa Only Heater
Spa Heat Pump	Spa Only Heat Pump
LS Lighting	Landscape Lighting
User Defined	Nameable Auxiliary Devices

5. Select the device connected to the LP position and press <Enter> to activate the selection.
6. Use the arrow keys to move to the next LP position assignment and repeat these steps until all LP devices are assigned.

When all assignments are complete, use left the arrow key to return to the **Device Setup** screen.

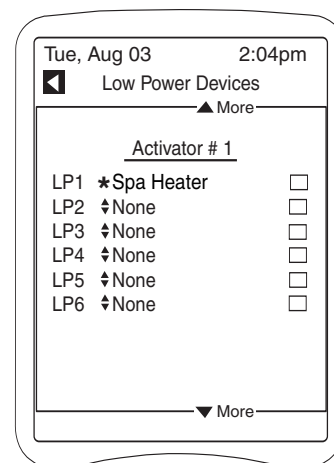

## Valves VLV1-VLV6

Defines the valve actuators connected to Eos.

General rules for valve assignments:

- Assign the suction valve and return valve separately.

To assign or reassign valves:

1. Move the cursor over the Valves VLV1-VLV6 folder and press <Enter> to open the **Valves** screen.
2. Move the cursor over the activator position to be assigned. (Ex: VLV1)
3. Press <Enter> to select the item. The item will flash.
4. Use the up/down arrow keys to access the valve options.

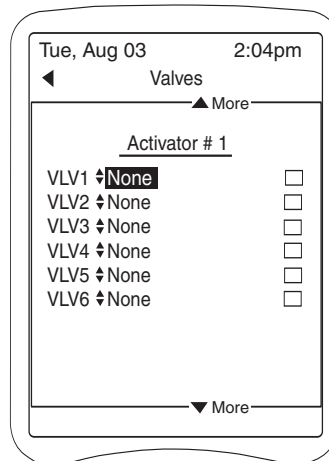

### Spa Only

#### Valve Options

#### Description

Solar Valve	Solar Valve Actuator
Backwash Supply	Backwash Supply Actuator
Backwash Drain	Backwash Drain Actuator
Feature Valve	Water Feature Valve Actuator
Waterfall Valve	Waterfall Valve Actuator
User Defined	Nameable Auxiliary Valve Actuator

5. Select the device connected to the valve position and press <Enter> to activate the selection.
6. Use the arrow keys to move to the next VLV position assignment and repeat these steps until all valves are assigned.

When all assignments are complete, use left the arrow key to return to the **Device Setup** screen.

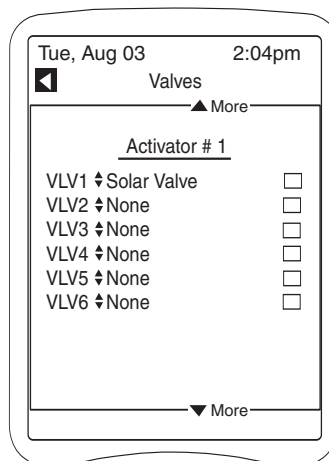



## Sensors SNS1-SNS6

Defines the sensors controlled by Eos.

There are five possible temperature sensors and one pressure sensor. One air and one water sensor (PS Sensor) are included. The sensors can be calibrated +/- 9°.

To assign or reassign a sensor:

1. Move the cursor over the Sensors SNS1-5, PRES folder and press <Enter> to open the **Sensors** screen.
2. Move the cursor over the activator position to be assigned. (Ex: SNS1)
3. Press <Enter> to select the item. The item will flash.
4. Use the up/down arrow keys to access the sensor options.

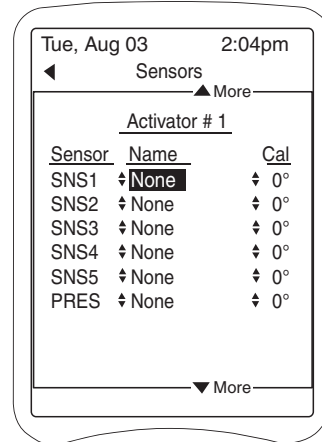

### Spa Only

#### Sensor Options

#### Description

Air Sensor	Air Only Temp Sensor
Spa Sensor	Spa Only Temp Sensor
Solar Sensor	Solar Only Temp Sensor
User Defined	Nameable Temp Sensor

5. Select the device connected to the sensor position and press <Enter> to activate the selection.
6. Use the right arrow key to move to the calibration (Cal) setting and adjust if desired. **CAUTION: Do not exceed high temperature recommendations.**
7. Use the arrow keys to move to the next SNS position assignment and repeat these steps until all sensors are assigned.

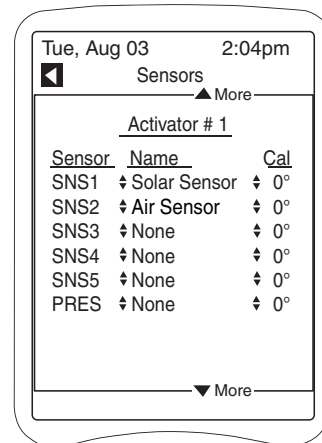

When all assignments are complete, use the left arrow key to return to the **Device Setup** screen.

Use down arrow key to move to the X-10 Devices folder to continue device setup or use the left arrow to return to the Setup screen and then the right arrow to move to the **Main Screen**.

# Device Setup - Configuration Separate

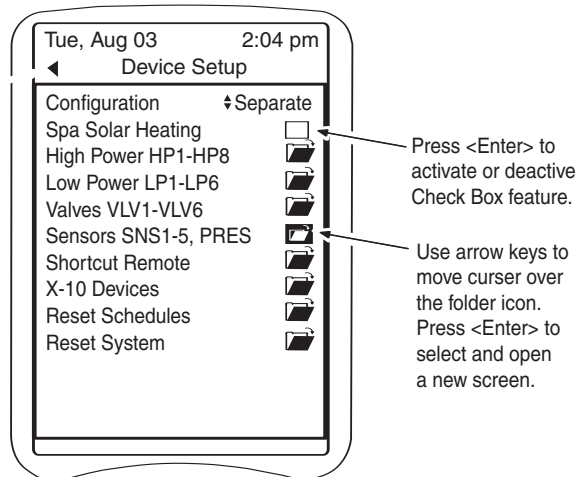

## Spa Solar Heating

This feature allows solar heating for the pool and spa. When the box is unchecked (default), solar heating is available in the pool only. When checked, solar heating is available for the spa only. Solar heating operates only when the Solar Sensor reads 5 degrees warmer than the water temperature.

## Device Screen Overview

The device screens (High Power HP1-HP8, Low Power LP1-LP6, Valves VLV1-VLV6 and Sensors SNS1-5, PRES) provide the means for defining the equipment that is connected to the command center.

Each device screen provides:

- Activator board position name. (Ex: HP1)
- Device name field. (Ex: **None**)  
Device lists are available when field is selected.
- Check box (except Sensors that have a calibration function).  
Checking the box activates the device connected at that position. Use to identify/verify device connections.
- Connection assignments for Activator #2, #3 and #4 (used if Extension Panels are installed) are accessed by moving the cursor to "More."

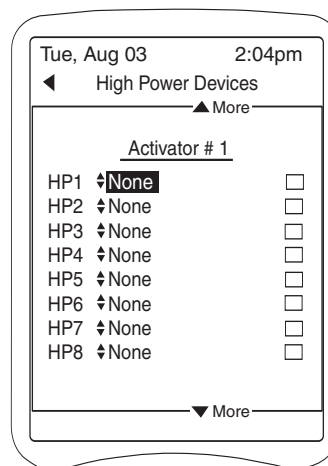



General rules for device assignments:

- **Device assignments must match the device's physical connection position** on the command center activator board.
- **Do not unplug devices from the activator board while the Eos is powered.**
- Some device options cannot be duplicated. If two or more devices need to change assignments, change them back to "None" and then reassign.
- Some devices, such as a dimmer, offer custom naming to distinguish multiple units or to personalize the device. These devices are displayed with an asterisk in front of the device name.

**User Defined** is an option for naming devices not included on the device lists. This option provides no equipment associations (see **Device Associations**).

#### Using Nameable Text Fields

- Move cursor over name field and press <Enter> to select. The last letter of the name will blink.
- Use the left arrow key to erase the item name.
- Use the up/down arrow keys to access the alpha-numeric options.
- Use the right arrow key to move to the next letter.
- Press <Enter> when the entry is complete.

To change the item back to "None," move to the asterisk and press <Enter>.

## High Power HP1-HP8

Defines the high power (120/240 VAC) devices controlled by the Eos and assigns them to their activator board connection positions.

General rules for HP device assignments:

- If the circulation pump is two-speed, identify the standard relay as the circulation pump and the 2-speed relay as low speed.
- If a fiber optic light driver is installed, identify the light driver as Fiber Optic and the color wheel as Color Wheel.
- If a dimmer is installed, select Dimmer and then rename the device to identify the light being dimmed (Ex: Spa Light Dim). Dimming capability is from 0 to 100%, in increments of 10.

To assign or reassign an HP device:

1. Move the cursor over the High Power HP1-HP8 folder and press <Enter> to open the **High Power Devices** screen.
2. Move the cursor over the activator position to be assigned. (Ex: HP1)
3. Press <Enter> to select the item. The item will flash.

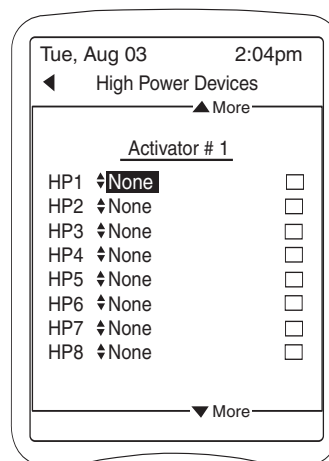



- Use the up/down arrow keys to access the HP device options.

**Separate**

<b>HP Device Options</b>	<b>Description</b>
Pool Circ Pump	Pool Circulation Pump
Pool Low Speed	Low Speed Pool Circulation Pump
Spa Circ Pump	Spa Circulation Pump
Spa Low Speed	Low Speed Spa Circulation Pump
Pool Heater	Pool Only Heater
Spa Heater	Spa Only Heater
Pool Heat Pump	Pool Only Heat Pump
Spa Heat Pump	Spa Only Heat Pump
Pool Chiller	Pool Only Chiller
Solar Pump	Solar Booster Pump
Cleaner Pump	Pressure Cleaner Booster Pump
Spa Jet Pump	HydroTherapy Jet Pump
Blower	Air Blower
Waterfall	Waterfall Pump
Water Feature	Waterfall Pump
Pool Light	Pool Only Light
Spa Light	Spa Only Light
Fiber Optic	Fiber Optic Light Driver
Color Wheel	Color Wheel for Light Driver
Lights	Accessory Lights
Dimmer	Nameable Pool or Spa Lights on Dimmer Relay
User Defined	Nameable Auxiliary Devices

- Select the device connected to the HP position and press <Enter> to activate the selection.

- Use the arrow keys to move to the next HP position assignment and repeat these steps until all HP devices are assigned.

When all assignments are complete, use left the arrow key to return to the **Device Setup** screen.

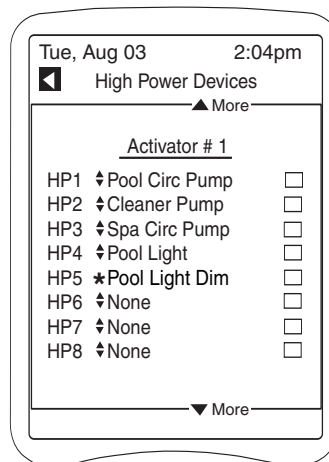



## Low Power LP1-LP6

Defines the low power devices controlled by Eos.

General rules for LP device assignments:

- If using multiple heaters, use the rename option to simplify identification. (Ex: Heater 1 and Heater 2, or Raypak and AquaCal)

To assign or reassign a LP device:

1. Move the cursor over the Low Power LP1-LP6 folder and press <Enter> to open the **Low Power Devices** screen.
2. Move the cursor over the activator position to be assigned. (Ex: LP1)
3. Press <Enter> to select the item. The item will flash.
4. Use the up/down arrow keys to access the LP device options.

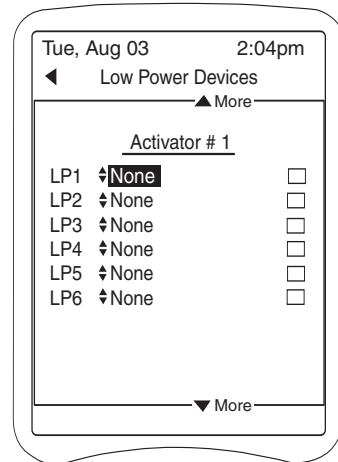

### Separate

LP Device Options	Description
Pool Heater	Pool Only Heater
Spa Heater	Spa Only Heater
Pool Heat Pump	Pool Only Heat Pump
Spa Heat Pump	Spa Only Heat Pump
Pool Chiller	Pool Only Chiller
LS Lighting	Landscape Lighting
User Defined	Nameable Auxiliary Devices

5. Select the device connected to the LP position and press <Enter> to activate the selection.
6. Use the arrow keys to move to the next LP position assignment and repeat these steps until all LP devices are assigned.

When all assignments are complete, use left the arrow key to return to the **Device Setup** screen.

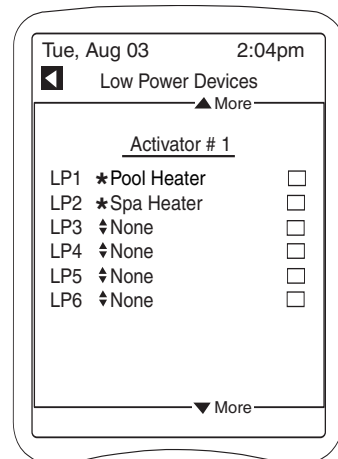

## Valves VLV1-VLV6

Defines the valve actuators connected to Eos.

General rules for valve assignments:

- Assign the suction valve and return valve separately.

To assign or reassign valves:

1. Move the cursor over the Valves VLV1-VLV6 folder and press <Enter> to open the **Valves** screen.
2. Move the cursor over the activator position to be assigned. (Ex: VLV1)
3. Press <Enter> to select the item. The item will flash.
4. Use the up/down arrow keys to access the valve options.

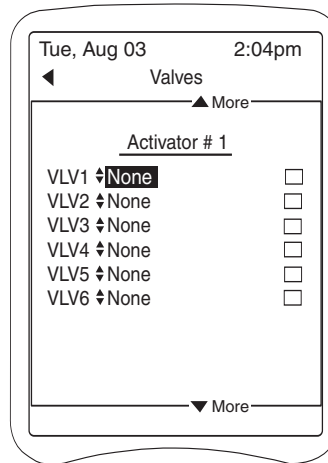

### Separate

#### Valve Options

#### Description

Solar Valve	Solar Valve Actuator
Cleaner Valve	Cleaner Valve Actuator
Backwash Supply	Backwash Supply Actuator
Backwash Drain	Backwash Drain Actuator
Feature Valve	Water Feature Valve Actuator
Waterfall Valve	Waterfall Valve Actuator
Infloor Valve	Infloor Control Valve Actuator
User Defined	Nameable Auxiliary Valve Actuator

5. Select the device connected to the valve position and press <Enter> to activate the selection.
6. Use the arrow keys to move to the next VLV position assignment and repeat these steps until all valves are assigned.

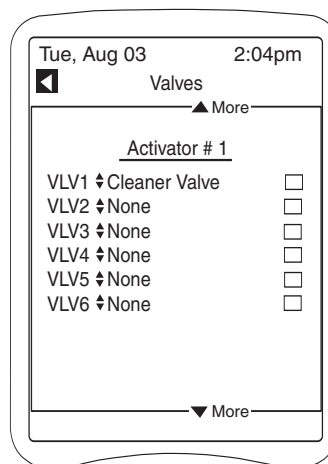

When all assignments are complete, use left the arrow key to return to the **Device Setup** screen.



## Sensors SNS1-SNS6

Defines the sensors controlled by Eos.

There are five possible temperature sensors and one pressure sensor. One air and one water sensor (PS Sensor) are included. The sensors can be calibrated +/- 9°.

To assign or reassign a sensor:

1. Move the cursor over the Sensors SNS1-5, PRES folder and press <Enter> to open the **Sensors** screen.
2. Move the cursor over the activator position to be assigned. (Ex: SNS1)
3. Press <Enter> to select the item. The item will flash.
4. Use the up/down arrow keys to access the sensor options.

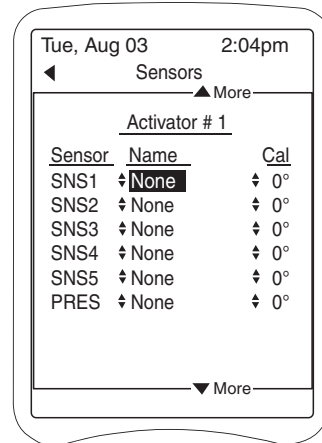

### Separate

#### Sensor Options

#### Description

Air Sensor	Air Only Temp Sensor
Pool Sensor	Pool Only Temp Sensor
Spa Sensor	Spa Only Temp Sensor
Solar Sensor	Solar Only Temp Sensor
User Defined	Nameable Temp Sensor

5. Select the device connected to the sensor position and press <Enter> to activate the selection.
6. Use the right arrow key to move to the calibration (Cal) setting and adjust if desired. **CAUTION: Do not exceed high temperature recommendations.**
7. Use the arrow keys to move to the next SNS position assignment and repeat these steps until all sensors are assigned.

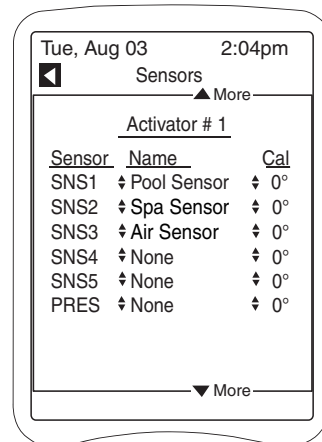

When all assignments are complete, use the left arrow to return to the **Device Setup** screen.

Use down arrow key to move to the X-10 Devices folder to continue device setup or use the left arrow to return to the Setup screen and then the right arrow to move to the **Main Screen**.

## PLC (X-10) Devices

The house code (A-D) and device code (1-16) that were set on each PLC Receiver must be defined.

1. With the cursor over the X-10 Devices folder, press <Enter> to open the **X-10 Setup** screen.
2. Move the cursor to the name field next to the code identifier position to be assigned. (Ex: A01)
3. Press <Enter> to select the item. A line indicating the text field will appear and the first character position will flash.
4. Enter the device name in the text field using the up/down keys to access the alpha-numeric characters and the left/right keys to move within the field. Press <Enter> when naming is complete.
5. If a dimmer module is installed, use the right arrow key to move to the dimmer (Dim) check box and press <Enter> to enable (check) dimming control for the device.  
  
Various settings between 0-100% are available to provide low to bright light levels.
6. Use the arrow keys to move to the next code position assignment and repeat these steps until all PLC devices are assigned.

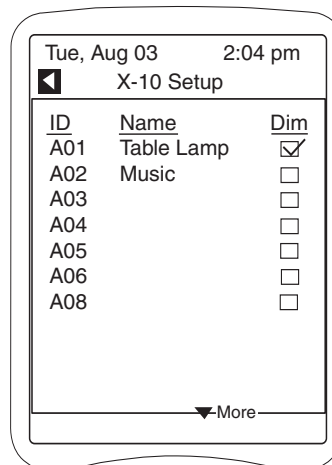
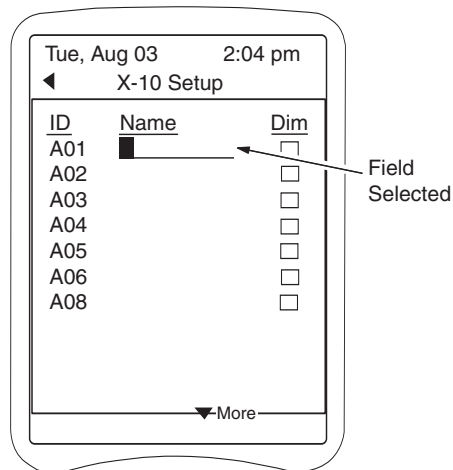

When all assignments are complete, use the left arrow to return to the Device Setup screen.

From Device Setup, use the left arrow to return to the Setup screen and then the right arrow to move to the **Main Screen**.



## Customizing the Main Screen

Once device setup is complete and the system devices are defined, the Main screen is displayed with the installation-specific device functions. This screen shows designated set points, lists the devices installed, provides access to the device manager folders, and displays current operational status readings.

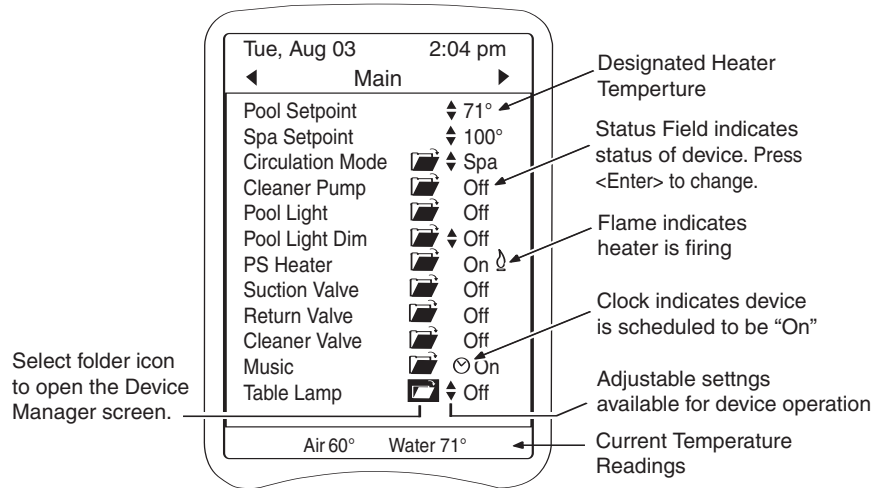

The screen can be customized, items reordered or devices grouped, to make the system easier to work with.

To move a device item up or down on the menu:

1. Move cursor to the Status field of the particular device.
2. Press and hold <Enter>.
3. Push the up or down arrow key to move the device.

To insert lines between menu items:

1. Move cursor to Status field of device you want to insert a line above.
2. Press and hold <Enter>.
3. Press the up and down arrow keys simultaneously. A space will be inserted above the item.

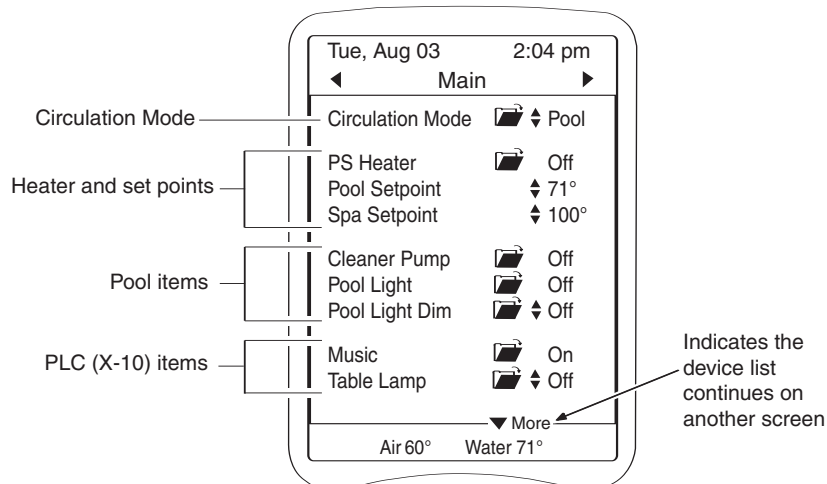



# Circulation Mode (Pool Circulation, Spa Circulation)

The options available for circulation mode are dependent on the configuration of the pool, the settings enabled and the equipment installed.

Configuration	Circulation Mode Options	Additional Settings With Two-Speed Pump
Combo with Spill Mode Enabled	Pool, Spa, Spill, Off	Pool LS, Spa LS, Spill LS
Combo without Spill Mode	Pool, Spa, Off	Pool LS, Spa LS
Pool Only	On, Off	On, Low, Off
Spa Only	On, Off	On, Low, Off
Separate Pool Circulation	On, Off	On, Low, Off
Spa Circulation	On, Off	On, Low, Off

To set (manually activate) the circulation mode:

1. Move the cursor over the status field (Ex: **Off** ) and press <Enter> to select. The item will flash.
2. Use the up/down arrow keys to access the circulation mode options.
3. Select the desired mode and press <Enter> to activate the selection.

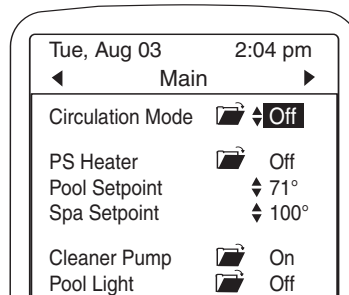

When a circulation mode is entered, either by manual activation or as a scheduled event, circulation pumps as well as the appropriate valve actuators will activate.

When set manually, the selected mode will run for as long as the Manual Duration (found in the device manager folder) specifies, if no other schedules are set.

To schedule the circulation mode:

Move the cursor over the circulation folder and press <Enter> to open the device manager screen.

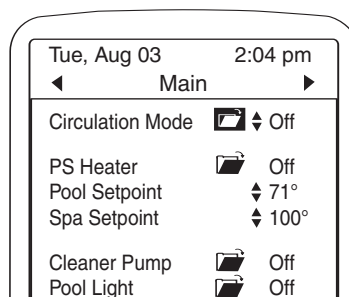



# Manual Control and Scheduling

## Device Manager Screens Overview

### Status

Indicates on/off status for most devices. For the pool/spa circulation pump it also indicates the current circulation mode (pool, spa, or spillover).

### Manual Control

Specifies how long a device will be active when turned on or inactive when turned off manually.

Each device has a **Duration** default. When the specified duration is complete, the device control returns to established schedules.

**Remaining** refers to how much longer the device will be active under manual control.

Manually activated devices are subject to device manager rules; therefore, even though a device may be “on”, it may not activate unless all rules are met. See **Safety Delays and Lockouts** for further information.

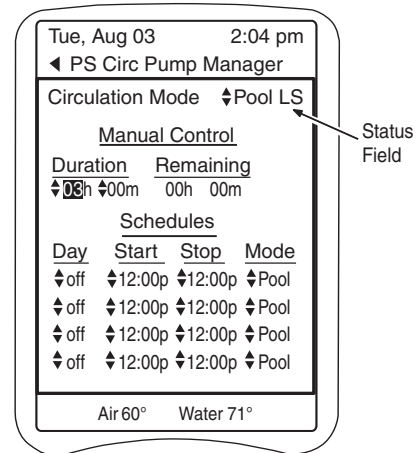

### Schedules

Activation schedules are available for each device. Up to four schedules can be set based on date and time.

**Day:** Specifies day(s) of operation (Sun, Mon, Tue, etc. or All) (M-F = Monday thru Friday) (S-S = Saturday and Sunday) (MWF = Mon., Wed. and Friday)

**Start:** Specifies start time

**Stop:** Specifies stop time

**Mode:** For circulation pump only: specifies circulation mode (pool, spa, spillover)

Schedule **priority is based on the order of the schedules** from the top (highest priority) to the bottom of the menu.

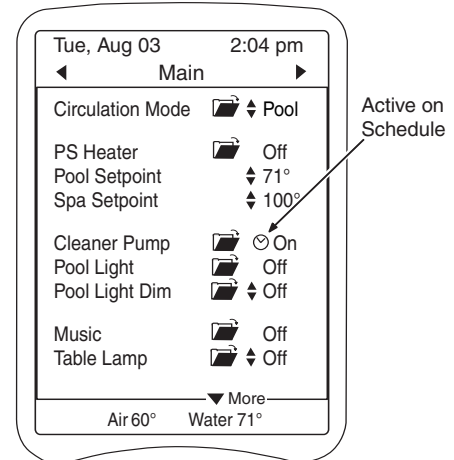

When scheduling, take into consideration the operational function of each piece of equipment. Some equipment is dependent on other equipment to operate correctly. Review all programmed equipment to ensure there are no potential conflicts.

When a device is scheduled and active, a clock symbol is displayed next to it on the Main screen.

### Freeze Protect

Enables or disables freeze protection for the device. Default is unchecked. Freeze Protection on the Setup screen must also be checked to activate.

## Circ Pump Manager

The same circulation options (including the low speed options for 2-speed pumps) available on the Main screen are available on the manager screens by selecting and adjusting the **Status** field.

When manually activated, the mode will run as long as the duration specifies. The default is 24 hours.

To set or change Duration:

1. Move the cursor over the hours (Ex: **03**) and press <Enter> to select. The item will flash.
2. Use the up/down arrow keys to set time.
3. Press <Enter> to activate the selection.
4. Use right arrow to move to minutes and set if desired.

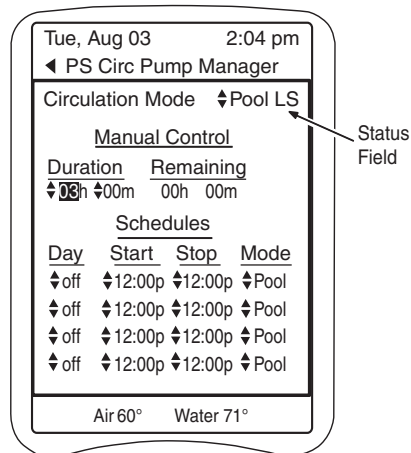

Schedules can be set for specific circulation modes. Schedule **priority is based on the order of the schedules** from the top (highest priority) to the bottom of the menu.

**Start** and **Stop** time can be set in hours and minutes with the am / pm setting designated by the hour.

To schedule circulation mode:

1. Use the arrow keys to move the cursor over the status field under Day (Ex: **off**) and press <Enter> to select. The item will flash.
2. Use the up/down arrow keys to set the day. Press <Enter> to activate the selection.
3. Move cursor to Start hour field and press <Enter> to select.

Use the up/down arrow keys to choose start time. Press <Enter> to activate. Set minutes if desired.

4. Move cursor to Stop. Set stop time, hours and minutes.
5. Move cursor to Mode, select circulation mode and press <Enter> to activate. Use the left arrow key to return to the **Main** screen.

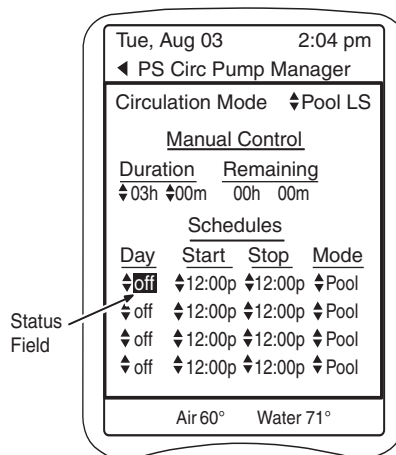



Some equipment such as heaters, solar valves, etc. have device-specific options listed on the manager screen.

## Heater Manager

On the Main screen, move cursor to the folder next to the heater. Press <Enter> to open the manager screen.

### Range

Adjustable operating ranges are available. The low and high defaults are 0° and 104°.

If only one heater is used or if multiple heaters are used within the same range, no adjustment of the default is necessary.

To set two heaters to heat together up to a certain temperature, such as 95° F, with only the second continuing to heat to 104° F:

1. In the first heater's manager screen, use the arrow keys to move the cursor over the high range setting (Ex: **104°**) and press <Enter> to select. The item will flash.
2. Use the up/down arrow keys to set the maximum desired temperature (Ex: 95°). Press <Enter> to activate the selection.
3. Leave the other heater at the 104° default.

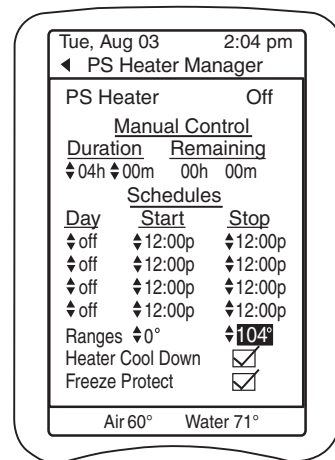

### Heater Cool Down

Default is checked (enabled). Provides a two minute-delay in turning off the circulation pump after heater has completed its firing cycle to allow the heater to cool down.

### Freeze Protect

Disabled (unchecked) by default. Heater will not fire during "Freeze Alert." If enabled (checked), heater will fire when water temperature drops to 33° F.



## Spa Dep Valve Manager

On the Main screen, move cursor to folder next to Spa Dep Valve. Press <Enter> to open the manager screen.

### Spa Mode Position

Sets the Spa Dependent Valve position when the system is in circulation mode "Spa."

1. Use the arrow keys to move the cursor over the Spa Mode Position field. (Ex: **Off**)
2. Press <Enter> to select On or Off.

## Solar Valve Manager

On the Main screen, move cursor to folder next to Solar Valve. Press <Enter> to open the manager screen.

### Solar Priority

Available on the Solar Valve Manager and Solar Pump Manager screens, sets solar heating to have priority over all other heaters.

When checked (default), the solar heater will have priority over other heaters until the water temperature gets within 5 degrees of the **Solar Panel Temp**. Then, solar heating will shut off and the other heater(s), if activated, will continue to heat until the set point is reached.

### Solar Panel Temp

Indicates the reading from the temperature sensor on the solar panel.



# Setting Scenes and Shortcuts

## Scenes

A Scene is a “snapshot” of the entire system operation that can be recalled to play at any time.

Scenes can be scheduled to run at specific times or activated manually.

Up to 5 Scenes can be set up but only one Scene can be played at a time. If a Scene is “in play” and another is recalled (either manually or by a schedule), the latter Scene takes priority.

To set a Scene:

1. From the **Main** screen, turn on any equipment that you want to operate during the Scene. Set points can be part of the Scene.

Move the cursor to the Status field of the each device and press <Enter> to select the setting.

In this example: circulation mode is Spa, Spa set point is 103°, Pool Light is On, Spa Light is dimmed to 60%, and Music is On.

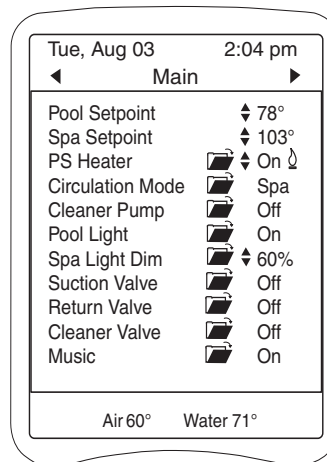

2. Use the left arrow key to move to the **Setup** screen.

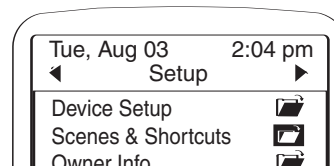

3. Move cursor to the Scenes & Shortcuts folder. Press <Enter> to open the **Scenes & Shortcuts** screen.

4. Move the cursor to the first available text field under My Scenes.

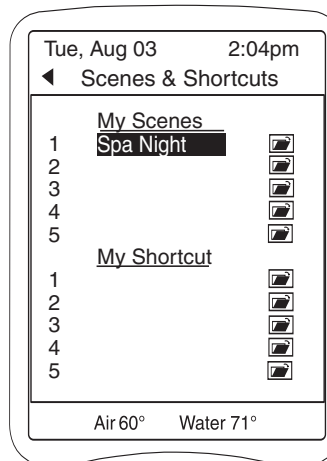

5. Press <Enter> to select the field and use the arrow keys to name the Scene. (Ex: **Spa Night**)
6. Move the cursor to the folder next to the newly named Scene and press <Enter> to open the **My Scene Manager** screen.



7. Move the cursor to **Save** and press <Enter> to capture the Scene.

The Scene “Spa Night” is saved.

Scenes can be scheduled just like any other device (see **Manual Control and Scheduling**).

8. The Scene is now displayed on the Main screen, just like a device, and can be activated (recalled) at any time by changing the Status to On.

The device manager for the Scene can also be accessed via the folder on the Main screen.

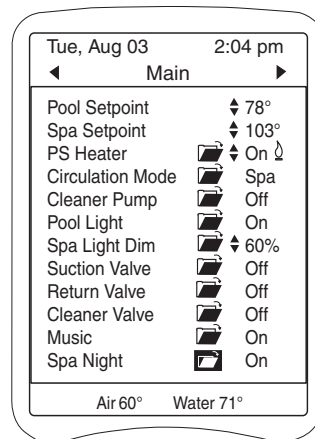

## Shortcuts

Shortcuts are also “snapshots” of system operation.

Unlike Scenes that turn devices on or off to set the scene, Shortcuts are only able to turn devices on.

Up to 5 Shortcuts can be set up and run simultaneously.

Shortcuts can run within a Scene, but Scenes cannot run within a Shortcut.

To set a Shortcut:

1. From the **Main** screen, turn on any equipment that you want to operate during the Shortcut.

Move the cursor to the Status field of each device and press <Enter> to select the setting.

In this example: Pool Light is On, Spa Light is dimmed to 60%, Porch Light is On, and LS (Landscape) Lighting is On.

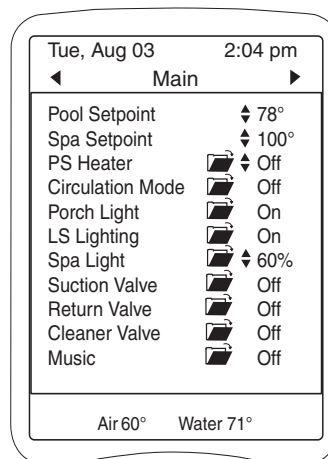



2. On the **Setup** screen, move cursor to the Scenes & Shortcuts folder. Press <Enter> to open the **Scenes & Shortcuts** screen.

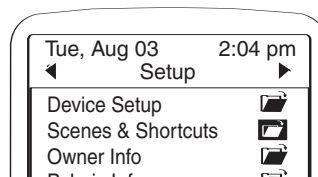

3. Move the cursor to the first available text field under My Shortcuts.

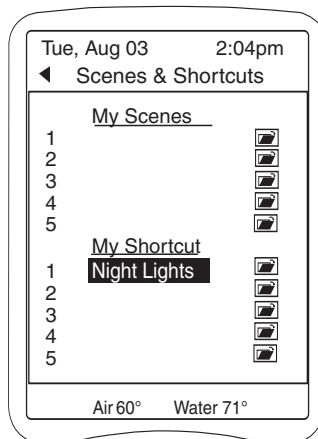

4. Press <Enter> to select the field and use the arrow keys to name the Shortcut. (Ex: **Night Lights**)

5. Move the cursor to the folder next to the newly named Shortcut. Press <Enter> to open the **My Shortcut Manager** screen.



6. Move the cursor to **Save** and press <Enter> to capture the Shortcut.

The Shortcut “Night Lights” is saved.

Shortcuts can be scheduled just like any other device (refer to **Manual Control and Scheduling**).

7. The Shortcut is now displayed on the Main screen, just like a device, and can be activated (recalled) at any time by changing the Status to On.

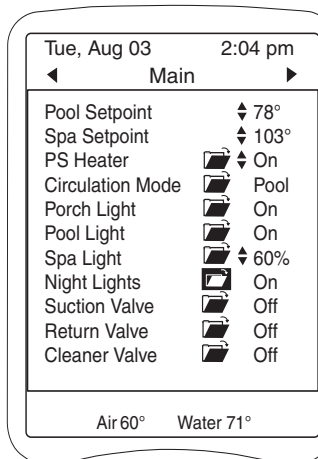

The device manager for the Shortcut can also be accessed via the folder on the Main screen.

# Remote Control Setup

To access the Setup screen for the Wireless or In-house Panel remotes, press the left and right arrow keys simultaneously.



## Wireless Remote Setup Screen

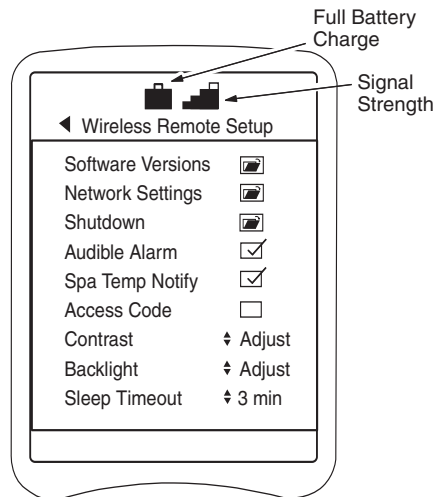

For optimum performance, the Wireless Remote should be used within line-of-sight of the antenna. **The battery must be charged for at least 5 hours before initial use.**

Battery charge level and signal reception are indicated at the top of the display screen. An animated scrolling battery symbol indicates battery is charging.

To save changes made to settings on this screen:

- Press left arrow key to exit the screen. A confirmation screen will open.
- Move cursor to Yes and press <Enter> to activate the change.



To reset the display if it is locked-up or frozen:

- Press and hold <Enter>.
- Press left and right arrow keys simultaneously.

### Software Version

Accesses current system software information.

### Network Settings

Preset at factory, no adjustments are necessary. Lists unique remote channel setting.

### Shutdown

Turns off the remote. Useful to conserve battery life. Press any key to reactivate.

### Audible Alarm

When enabled (checked), the alarm **in this remote device** signals when an alert condition exists. Alert messages are displayed on the Main screen.



## Spa Temp Notify

If enabled (checked), “Spa Has Reached Set Temp” is displayed when the water temperature in the spa reaches its designated set point.

## Access Code

An additional security feature available on the remote control devices. When enabled, system change capabilities are limited to authorized users.

To set:

1. Enable (check) the Access Code box. A new screen will open and request a code.
2. Press any four keys on the keypad, in any order. Press <Enter> to
3. Use the left arrow key to exit the Setup screen.
4. The confirmation screen will appear. Move cursor to Yes and press <Enter> to activate the change.

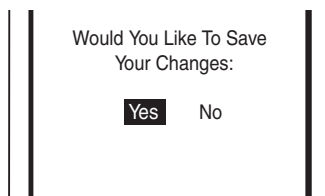
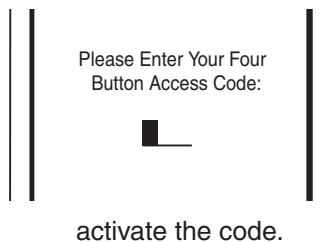

All function selections will lock requiring input of the access code to make changes.

To reset if code is forgotten:

1. Press the left and right arrow keys simultaneously to open the Setup screen.
2. Disable (uncheck) the Access Code box.
3. Press left arrow key to exit the Setup screen. Move cursor to Yes on the confirmation screen and press <Enter> to activate the change.

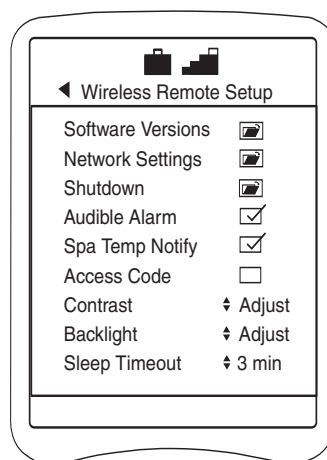

## Contrast

Controls readability of text, light or dark, on screen.

## Backlight

Controls illumination of screen for nighttime use and brightens for normal usage.

## Sleep Timeout

To conserve battery life, the remote can be switched to sleep mode after a specified length of time without activity.

If the wireless remote is purchased with the Eos Command Center, it is factory set for communication. If the remote is purchased separately or is a second remote on the system, it must be configured for communication.



### To configure remote for communications:

1. Select Network Settings and press <Enter> to open the **Network Settings** screen.
2. If two remotes are to be used on the system, assign each remote its own unique **Remote Address**. (Ex: set first remote to 101 and second to 102)
3. Enter the system SSID and Key number for the remote. The **SSID** is the antenna serial number (located on left side of the antenna) with three leading zeros. The **Key** consists of two rows of numbers, the second row is the serial number with four leading zeros.
4. When entries are complete, press the left arrow key to exit the screen. Press the left arrow key again to exit the Setup screen. The confirmation screen will open. Move the cursor to Yes and press <Enter> to activate the change.

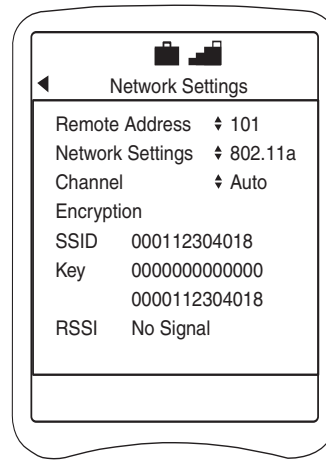

## In-House Panel (Wired Remote) Setup Screen

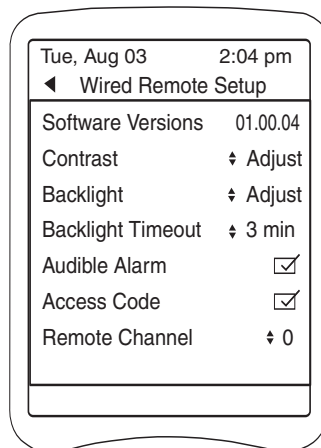

### Software Version

Specifies the active software version.

### Contrast

Controls readability of text, light or dark, on screen.

### Backlight

Controls illumination of screen for nighttime use and brightens it for normal usage.



## Backlight Timeout

Sets a time limit for inactivity after which the backlight on the display turns off. Time range is 1 to 10 minutes, 1 hour or On.

Hit any key to reactivate the display.

## Audible Alarm

When enabled (checked), the alarm **in this remote device** signals when an alert condition exists. Alert messages are displayed on the Main screen.

## Access Code

An additional security feature available on the remote control devices. When enabled, system change capabilities are limited to authorized users.

To set:

1. Enable (check) the Access Code box. A new screen will open and request a code.
2. Press any four keys on the keypad, in any order. Press <Enter> to activate the code.

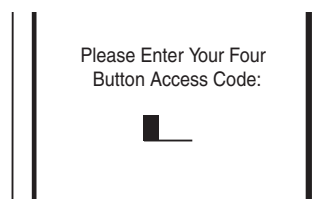

All function selections will lock requiring input of the access code to make changes.

To reset if code is forgotten:

1. Press the left and right arrow keys simultaneously to open the Setup screen.
2. Disable (uncheck) the Access Code box.

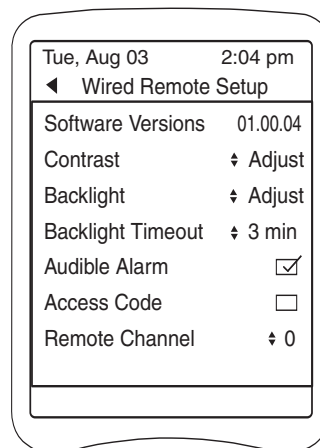

## Remote Channel

If two In-House Panels are installed on a system, the second must be adjusted to a different channel to allow simultaneous use.



## ShortCut Remote

The control functions of the Shortcut buttons (A, B, C, D) must be defined on the Shortcut Remote manager screen accessed from the Device Setup screen. In addition to two factory-set functions, up to 8 control functions can be assigned.

**All devices, Scenes and Shortcuts must be set up to become available under the button function lists.**

General guidelines for Shortcut button function assignments:

- Any device, Scene, or Shortcut listed on the Main screen can be controlled by the Shortcut remote.
- If lights (including dimmers) are setup, the remote controls only the on/off function of the device.
- Temperature controls are the default on buttons A and B, if a heater has been set up. Different temperature options will become available depending on the configuration mode.

### Configuration

Combo with 1 heater  
(PS Heater)

Combo with 2 heaters  
(Pool Heater and Spa Heater)

Separate with 2 heaters  
(Pool Heater and Spa Heater)

### Temperature Options

Spa Temp Up and Spa Temp Down

Spa Temp Up and Spa Temp Down  
Pool Temp Up and Pool Temp Down

Spa Temp Up and Spa Temp Down  
Pool Temp Up and Pool Temp Down

If multiple Spa Heaters are set up, the A/B button temperature functions will control the last heater set up.

- All 8 shortcut assignments, 4 on Shortcut #1 and 4 on Shortcut #2, are enabled (check box checked) by default.

To assign control functions:

1. Perform setup from the command center display panel.
2. Go to **Setup** screen and highlight the Device Setup folder. Press <Enter> to open the **Device Setup** screen.
3. Move cursor down to **Shortcut Remote** and press <Enter> to open the manager screen.

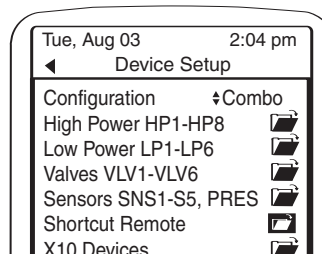
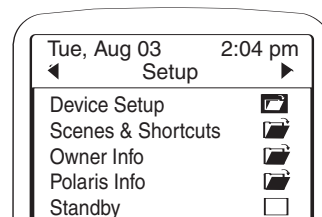



4. Move the cursor to the field next to Key (button) A and press <Enter> to select the field.

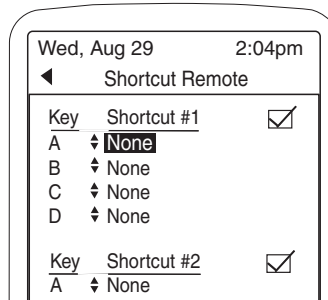

5. Use the up or down arrow key to select the control assignment. Press <Enter> to activate the selection.

6. Use the down arrow key to move to the field next to each Key, selecting the field and assigning controls for each.

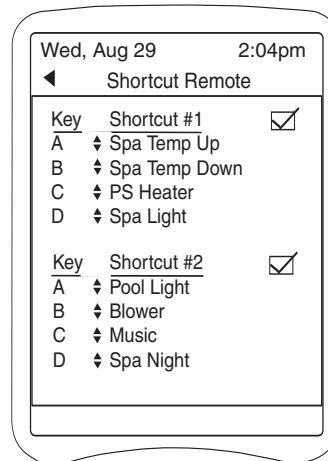

7. After assigning the button functions, mark the buttons with the labels provided.

The check boxes enable the functions associated with the Shortcut (#1 or #2). To disable the functions, move the cursor to the associated check box and press <Enter> to uncheck.

## Shortcut Operation

Button LEDs light when their respective device is active.

Temp Up and Temp Down button LEDs will only light when the buttons are pushed.

Temp Up and Temp Down buttons will increase or decrease the temperature set point by one degree.

When the maximum temperature is reached (104 degrees for Spa), the Temp Up button LED will stay lit.

**To switch between Shortcut #1 and Shortcut #2 controls**, press buttons A and C simultaneously. The two button LEDs will flash and then the active shortcut button (i.e., A = Shortcut #1) will illuminate.

**To activate the heater**, press buttons A and B simultaneously. The two button LEDs will flash together three times. While the heater is firing, the two button LEDs will flash every 15 seconds. When the set point is reached the flashing will stop..

**To activate Spa Mode**, press buttons C and D simultaneously. All LEDs will flash three times.

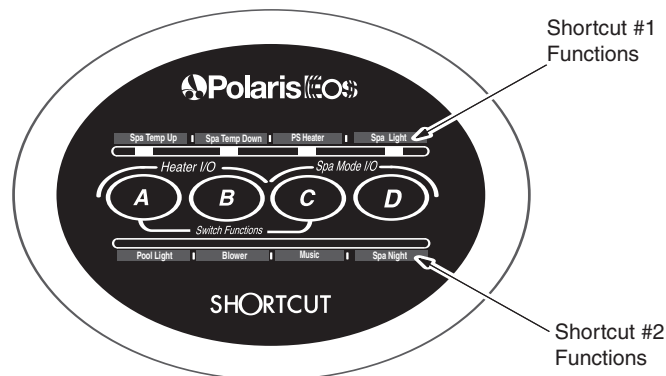

# Optional Controllers



## Polaris Watermatic C2100 ORP/pH Controller

If a Watermatic controller is installed, a separate control screen is provided to monitor readings and access the controller parameters. If a second controller is used, a second control screen will become available.

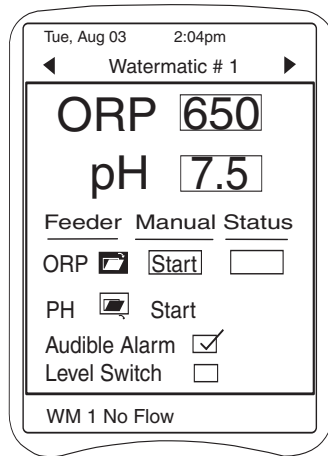

When a controller is installed, an optional nameable field becomes available on the **Setup** screen. If two controllers are installed, there will be nameable fields for each.

To name the controller:

1. Move the cursor to the Watermatic #1 (text field) and press <Enter> to select the field.
2. Use the up or down arrow keys to move through the alpha-numeric options and the left/right arrow keys to move within the field. (Ex: **Pool**)
3. Press <Enter> when the entry is complete.

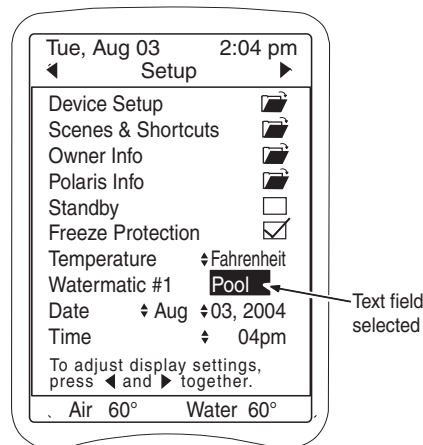

Refer to the C2000/C2100 Owner's Manual for complete operation and maintenance information.



## Salt Chlorinators

If a Polaris AutoClearPLUS or other salt chlorinator is connected to the Eos command center, a control screen is provided to monitor salinity levels and access the chlorinator settings. The screen name is designated by the chlorinator software.

If the AutoClearPLUS is connected to a Watermatic C2100 that is controlled by the Eos system, the Salt Chlorinator screen will not be displayed. Salinity and chlorine production will be monitored and controlled by the Watermatic, making this separate control screen unnecessary.

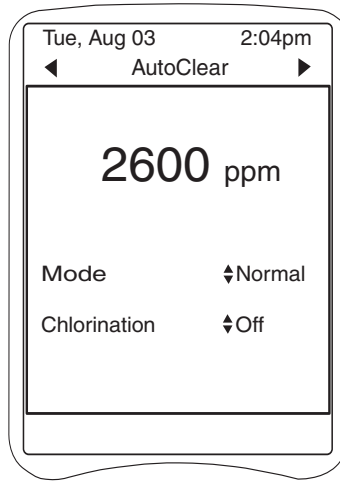

The current salt concentration or **salinity** of the pool is displayed in parts per million (PPM).

### Mode

Provides operational mode options:

Normal – Chlorine production at normal rate.

Super – Produces the maximum amount of chlorine for 24-hours, then reverts back to normal mode. If selected, the pool pump must be activated for a 24-hour run cycle as well.

Service – Disables control while chlorinator is being serviced.

### Chlorination

Adjusts the chlorine output from 0 to 100% in increments of 10.

Consult the chlorinator manual for recommended salinity levels, and complete operation and maintenance information.

# System Operation



When all equipment setup is complete, manually check the operation of each device using the check boxes on the individual device setup screens (select **Device Setup** folder on **Setup** screen, then the device folder for each type of equipment) or by changing the device status on the Main screen.

**Note:** Manually activated devices are subject to device manager rules; therefore, even though a device is “on,” it will not activate unless all rules are met. For example, although the heater is turned “on,” it will only fire (indicated by the flame) if the circulation pump is on and the temperature set point is above the current temperature reading.

During normal operation, the **Main** screen provides access to the most commonly needed information such as temperature set points, status of devices and quick access to device schedules.

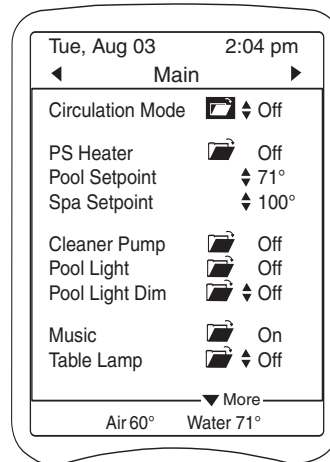

## Service Mode

Service mode can only be accessed from the command center key board display. During service mode, the in-house panel and wireless remote displays will show “Service Mode” and no system operation will be available.

To enter service mode:

1. Press and hold SVC key for 2 seconds. The Service screen will open and all pool equipment will shut off.
2. When service is complete, use left arrow key to return to the Main screen.

To set a **Timeout** duration, disabling activation schedules, scenes or shortcuts so equipment can be serviced:

1. Move cursor to duration field (Ex: **None**) and press <Enter> to select.
2. Use up or down arrow key to set duration and press <Enter> to activate it. When timeout is complete or service mode is exited, normal operation will resume.

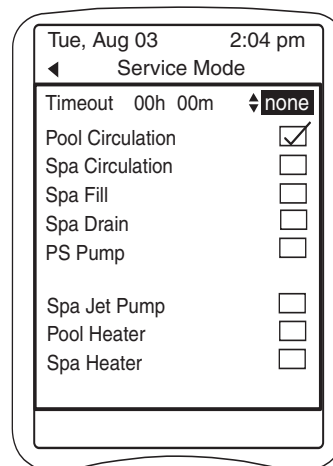

Equipment is turned On or Off using the check boxes to the right of the device.

In Combo configuration, suction and return valve positions are listed first. Only one valve can be activated at a time.



## Freeze Protection

Freeze protection is activated when the air temperature drops to 36°F or the water temperature reaches 34° F. Manual or scheduled operation of Spa Mode will override freeze protection.

During freeze protection, “Freeze Alert” will flash on the bottom of the command center or remote display screen.

The **Freeze Protection** check box on the Setup screen is checked (enabled) by default. If unchecked, all equipment controlled by Eos is removed from freeze protection.

The circulation pump is covered by freeze protection as long as this check box is checked.

For all other equipment, **Freeze Protect** must also be specified on the individual device manager screen. Some devices default to freeze protect.

By default, heater freeze protect is unchecked: the heater will not fire during a freeze alert. If freeze protection is checked, the heater will fire when the water temperature drops to 33° F.

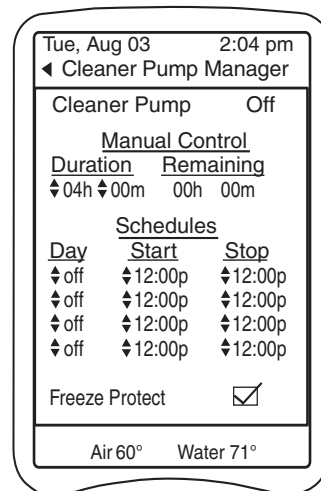
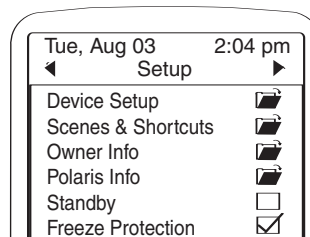

During Freeze Alert:

- In the Combo and Separate configurations, the system will alternate between activating the spa and the pool equipment every 15 minutes.
- In Spa Only and Pool Only configurations, the equipment will alternate for 15 minutes On and 15 minutes Off.
- Blowers will run for 5 minutes every half hour.
- No lighting (pool, spa, landscape, etc.) will activate.

## Alerts and Alarms



The following alert conditions will sound the audible alarm in addition to displaying the alert.

### Alert

Pool High Temperature  
Pool Low Temperature  
Spa High Temperature  
Spa Low Temperature  
Wireless Remote Battery Low  
WM#1 High PH Alert  
WM#1 Low PH Alert  
WM#1 High ORP Alert  
WM#1 Low ORP Alert  
WM#1 PH Overfeed  
WM#1 ORP Overfeed  
WM#1 Feeder Empty

### Alert

WM#2 High PH Alert  
WM#2 Low PH Alert  
WM#2 High ORP Alert  
WM#2 Low ORP Alert  
WM#2 PH Overfeed  
WM#2 ORP Overfeed  
WM#2 Feeder Empty

The following Alerts are flashing messages only.

### Alert

Freeze Alert  
WM#1 No Flow  
WM#1 2 Minute Flow Delay  
WM#1 Clean PH Sensor  
WM#1 Cal PH Sensor  
WM#1 Clean ORP Sensor  
WM#2 No Flow  
WM#2 2 Minute Flow Delay  
WM#2 Clean PH Sensor  
WM#2 Cal PH Sensor  
WM#2 Clean ORP Sensor  
Solar Purge Delay  
Solar Panel Temp Too Low  
Spa Has Reached Set Temp

### Alert

Cleaner Requires Pool Mode  
Standby Mode  
CPC-ACT Comm Failure (Cable/Activator)  
CPC-WM1 Comm Failure (Watermatic)  
CPC-WM2 Comm Failure  
SCB Comm Failure  
X10 Comm Failure  
Valves Turning  
Heater Cooling Down  
91 Check Salt  
92 Chlorinator No Flow  
Check Chlorinator



## Device Associations

### High Power and Low Power Devices

Device	Operational Device Interlocks	Delays
PS Circ Pump	Heaters, Cleaner & Solar Pump, Solar Valve	None
Pool Circ Pump	Heaters, Cleaner & Solar Pump, Solar Valve	None
Spa Circ Pump	Heaters, Solar Pump & Valve	None
Cleaner Pump	Circulation Pump, Solar Valve & Pump	Prime Delay (1 min., 4 min. Solar)
Solar Pump	Circulation Pump, Solar Valve, Temp Sensor	Prime Delay (45 sec.)
Spa Jet Pump	None	None
PS Heater		
Pool Heater	Circulation Pump	
Spa Heater	Multiple Heaters	Fire Delay (1 min.), Heater Cool Down (2 min.)
PS Heat Pump	Solar Pump & Valves	
Pool Heat Pump	Temp Sensors	
Spa Heat Pump		
Pool Chiller		
Blower	None	None
Color Wheel	Fiber Optic Light Driver	None
Dimmer	None	None
Fiber Optic	None	None
Lights	None	None
LS (Landscape) Lighting	None	None
PS Lighting	None	None
Pool Light	None	None
Spa Light	None	None
PS Low Speed	Circulation Pump	None
Pool Low Speed	Circulation Pump	None
Spa Low Speed	Circulation Pump	None
Water Feature	None	None
Waterfall	None	None
User Defined	None	None

### Valves

Device	Operational Device Interlocks	Delays
Backwash Drain	Backwash Supply, Pressure Sensor	None
Backwash Supply	Backwash Drain, Pressure Sensor	None
Cleaner Valve	None	None
Feature Valve	None	None
Infloor Valve	None	None
Return Valve	Pool/Spa/Spill Circulation Modes	None
Solar Valve	Heaters, Temp Sensor, Spa Circulation Mode	None
Spa Dep Valve	Pool/Spa/Spill Circulation Modes	None
Suction Valve	Pool/Spa Circulation Modes	None
Waterfall Valve	None	None
User Defined	None	None

### Sensors

Device	Operational Device Interlocks	Delays
PS Sensor	Heaters, Freeze Protection	None
Pool Sensor	Heaters, Freeze Protection	None
Spa Sensor	Heaters, Freeze Protection	None
Air Sensor	Freeze Protection	None
Solar Sensor	Solar Pump & Valve	None
User Defined	None	None

## Safety Delays and Lockouts

### 1. Heater

When activated (turned on manually or via the schedule), the heater will only fire (indicated by flame on display) if the circulation pump is on and the temperature set point is above the current temperature reading.

There is a 45-second operational delay at initial startup of the heater. Once the heater is active and the desired temperature is reached, the heater will turn off and remain off until the temperature falls two degrees below the set point. This prevents the heater from short cycling (i.e., turning on and off in rapid succession).

After the heater shuts down, it enters a 2-minute cool down period. **Heater Cooling Down** will be displayed on the screen. If the filter pump is shut down during the cool down, the pump will remain on until the delay is finished and an hourglass will be displayed next to the pump on the screen.

### 2. Cleaner Booster Pump

The pool cleaner will only activate when the system is in the pool mode (i.e., water circulating to the pool) as it requires water circulation to function correctly. **Cleaner Requires Pool Mode** is displayed if cleaner schedule requires circulation mode adjustment.

There is a 1-minute prime delay to ensure the water is flowing to the booster pump. The display will read **Prime Delay** during this delay.

If the filter pump is turned off while the cleaner booster pump is running, the controller will automatically shut down the booster pump. The system recognizes that the booster pump cannot run without the circulation pump.

If the booster pump cleaner is active and spa or spa spillover mode is entered the booster pump will shut down and be locked-out. When the spa or spa spillover mode is cancelled, the booster pump schedule will resume.

### 3. Spa Drain

The spa drain can only be activated on the Service screen.

### 4. Valves

**Valves Turning** is displayed whenever a valve (pool to spa, spa to spillover, solar, etc.) is signaled to rotate. There is a 15 second delay during which the filter pump is shut off. The pump is reactivated when the valves have stopped turning.

### 5. When the equipment is manually activated:

Existing schedules will be overridden. Remember to shut down the equipment, otherwise, the equipment will continue to run until the next scheduled shut down or time-out specified in the device setup.

If spa mode is not turned off, only the water in the spa will be filtered and the pool cleaner will be disabled.

Turning off the filter pump does not reset valves to pool mode. The valves will automatically return to pool mode after 6 hours.

### 6. Solar Heating Systems

When solar heating is initiated and there is a booster pump cleaner on the system, the booster pump will shut down and be locked-out for a 2-minute **Solar Purge Delay** to allow water to be purged from the solar collectors. When the delay is complete, the booster pump is reactivated.

### 7. Communication Failures

Communication failure messages (**CPC-ACT Comm Failure, X10 Comm Failure, etc.**) are displayed when there is a communications failure between the command center and the system components. Check connections or reposition the remote or antenna and try again.





# Troubleshooting

**Action: The display screen is blank.**

- Solution:
1. Confirm power is on to command center.
  2. Press any key to reactivate from Backlight Timeout, Shutdown or Sleep Timeout.
  3. Adjust the contrast setting of the display (via Command Center Setup Screen or remote setup screen) if it is too high or too low.

**Action: System setup is complete but components do not function.**

- Solution:
1. Verify that the activator position assignments for the equipment match the actual physical connection positions on the command center activator board.
  2. Confirm that device assignments accurately reflect equipment and configuration e.g., the shared pool/spa heater is defined as "PS Heater." User Defined should only be used if a device is not available in equipment lists.
  3. If component is a remote or external controller, open **Software Versions** on the Command Center Setup screen to verify that the device is listed. Ex: "Telnet" is listed if a Wireless Antenna is installed.
  4. Check wiring connections at the command center and the component.

**Action: Device (heater, pump, etc.) or feature comes on when activated but immediately turns off.**

- Solution:
1. Verify that the **Duration** setting on the device manager screen has not been incorrectly set to zero.

**Action: Wireless remote is not communicating with the command center.**

- Solution:
1. Verify that the remote is charged (and was charged at least 5 hours before the initial use).
  2. Confirm that the remote is within the coverage area of the antenna.
  3. Check the command center's **Software Versions** and verify that "Telnet" is listed. If not, make sure that the antenna wiring connections are secure and undamaged.
  4. Check accuracy of pin/wire color sequence at antenna and command center.
  5. Check the remote's **Network Settings**. Verify that the Eos SSID number is the antenna serial number (located on left side of the antenna) with three leading zeros, and the second row of the Key number is the serial number plus four leading zeros.



**Action: The heater does not fire when activated.**

- Solution:
1. Confirm that heater is not in the 45-second startup delay.
  2. Confirm that the circulation pump is running and the temperature set point is above the current temperature reading.
  3. If the pool is a pool/spa combination sharing one heater (Combo configuration), verify that the temperature sensor is assigned as "PS Sensor," the heater is assigned as "PS Heater," and the circulation pump is assigned as "PS Circ Pump."
  4. Check the **Range** settings (found on heater manager screen) of the heater. The upper range should be set above and the lower range below the actual water temperature.
  5. Verify heater connection on the activator board.
  6. Check heater manufacturer's instructions for correct wiring at heater.







Your pool. Our reputation.

USA: 2620 Commerce Way, Vista, CA 92081-8438 • 760-599-9600 • 1-800-822-7933

[www.polarispool.com](http://www.polarispool.com)

# Polaris Eos® Wireless Antenna and Remote Installation Instructions

## Installation

### Wireless Antenna

Mount the antenna in a high location, in line-of-sight with the wireless remote and in the center of the coverage area. Avoid areas where the radio signal must pass through fencing, stucco walls, reinforced block walls, etc.

1. Open the antenna door and connect cable wires to the removable terminal block using this color-coded sequence:

Pin #	Wire Color
1	Green
2	Yellow
3	Orange
4	Red
5	Blue + Brown
6	Black + Purple

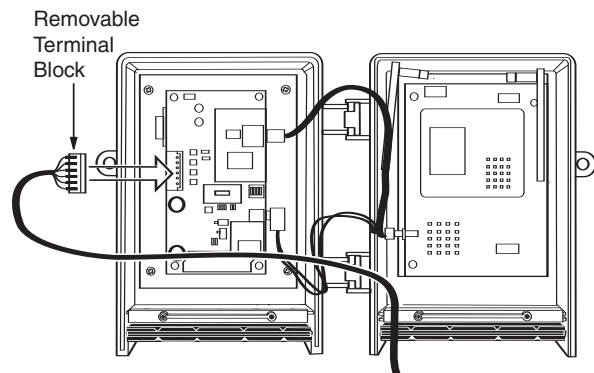

2. Remove the wire clamp and feed the wire into the left-most position, leaving about 12" of extra cable in the box. Push the wire into the rubber grommet seal. Reinstall the clamp and close the box.

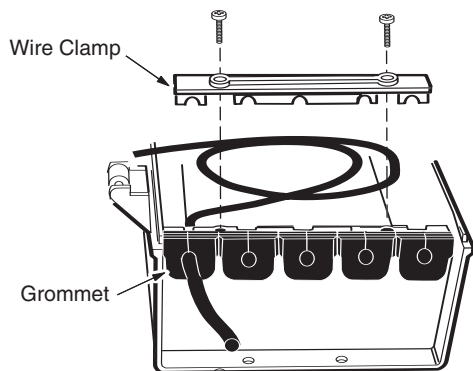

3. Route the antenna cable to the Eos Command Center and in through the low voltage compartment.
4. Unscrew and swing down the hinged board plate to access the circuit boards.
5. Connect the antenna wire to the removable terminal on the command center board using the same pin/color sequence. To connect multiple remotes with the antenna, install a RBC Hub Card (part #E36).

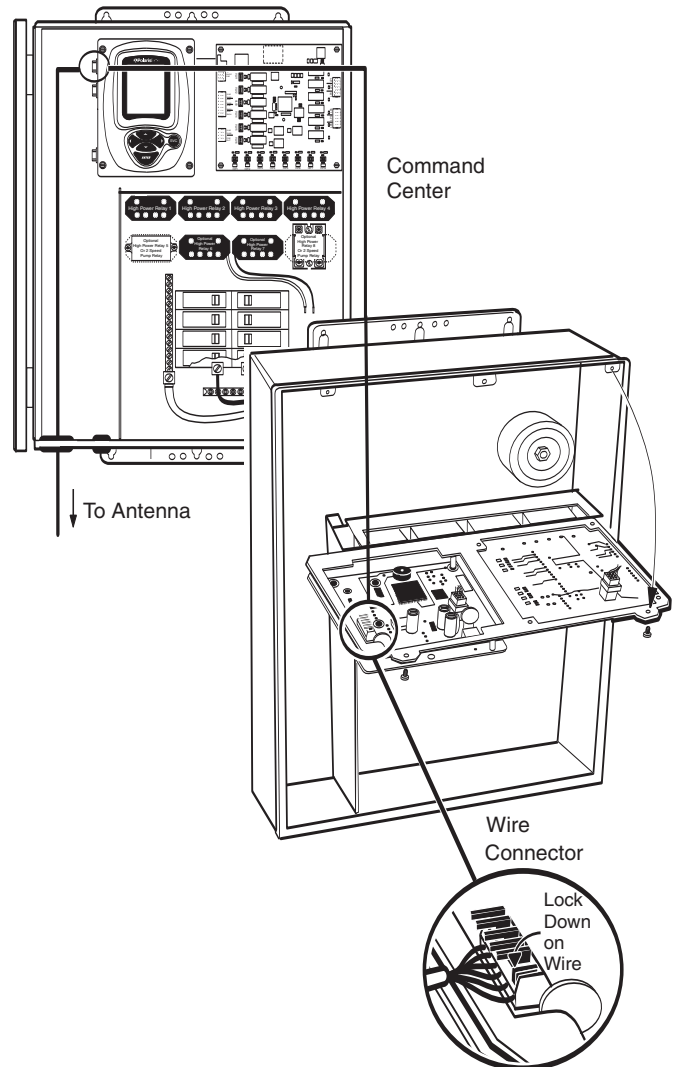

For installations with multiple antennas, the wires can terminate at the Command Center or be wired to the terminal block of another antenna or wired remote (max. 2000 ft.).

**After all connections are complete, power-up the Eos Command Center to verify that communication has been established.**

## Wireless Remote

Position the remote and charging base in a location away from prolonged direct sunlight.

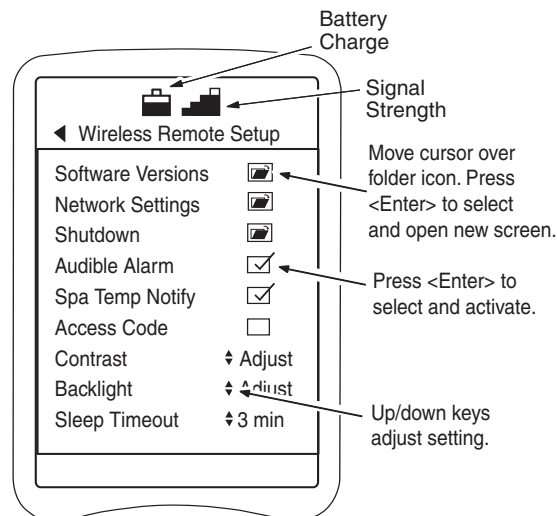
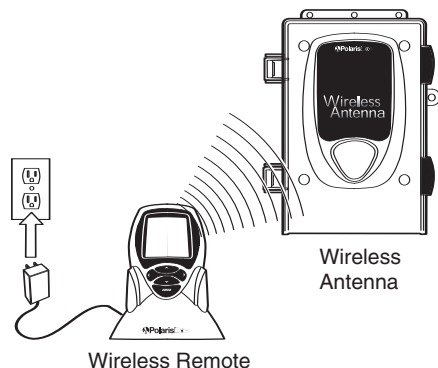

The wireless remote uses the Polaris rechargeable Lithium ion battery (part #E33). The battery must be charged for at least five (5) hours before use. Charging is indicated by an animated scrolling of the battery symbol on the display.

With a full charge, the remote can operate for up to two days, depending on usage. It is normal for the battery to discharge when not in use. To ensure a full charge, always store remote on the charging base when not in use. To replace the battery contact a Polaris service professional.

## Wireless Remote Setup

System measurements and settings are displayed on the remote display screens. Adjustments are made with the keypad. Use the cursor control (arrow) keys to move through the screens and menu options. Use the enter key to select an item.

Display settings such as brightness, contrast, etc. as well as certain device-specific settings are adjusted separately for each display device using the display setup screens.

For a complete description of using the wireless remote, refer to the **Eos Installation and Maintenance Guide** or **Eos Owner's Manual**.

If the remote is purchased with the Eos Command Center, it is factory set for communication. If the remote is purchased separately or is a second remote on the system, it must be configured for communication via the setup screen.

### To access the Wireless Remote Setup screen:

1. Press the left and right arrow keys on the remote simultaneously to open the Wireless Remote Setup screen.

When activated, the **Audible Alarm in this device** signals when an alert condition exists. Alert messages are displayed on the Main screen.

Select **Contrast and Backlight** to adjust the display features to user preferences.

### To configure remote for communications:

1. Select Network Settings and press <Enter> to open the **Network Settings** screen.
3. If two remotes are used with the antenna, assign each remote its own unique **Remote Address**. (Ex: first remote is set to 101 and second is set to 102)
2. Enter the system SSID and Key number. The **SSID** is the antenna serial number (located on left side of the antenna) with three leading zeros. The **Key** consists of two rows of numbers, the second row is the serial number with four leading zeros.

