

HiLite[®] Underwater Light Operating Procedures

IMPORTANT SAFETY INSTRUCTIONS READ AND FOLLOW ALL INSTRUCTIONS SAVE THESE INSTRUCTIONS

Table of Contents

	<u>Minimum Qualifications</u>	<u>Page</u>
Section I. Installing a light fixture during new pool construction.	Licensed or Certified Electrician	1
Section II. Replacing light fixture in existing pools.	Electrician or Qualified Pool Serviceman	3
Section III. Replacing a lamp only.	Qualified Pool Serviceman or Homeowner	6

NOTE

Use this light fixture with Pentair Pool Products light fixture housing 792066 or 7824XX, (SN 750 or SNL 750).

⚡

⚠ DANGER

RISK OF ELECTRICAL SHOCK OR ELECTROCUTION

This Underwater Light must be installed by a licensed or certified electrician in accordance with the National Electrical Code and all applicable local codes and ordinances. Improper installation will create an electrical hazard which could result in death or serious injury to pool users, installers or others due to electrical shock, and may also cause damage to property. Read and follow the specific instructions below.

Section I. Installing a light fixture during new pool construction.

- A. Preparatory steps which must be completed by the electrician before light is installed, see Figure 1.
1. Ensure that the electrical system of your pool conforms with all requirements of the National Electrical Code (NEC), and all local codes and ordinances. A licensed or certified electrician must install the electrical system to meet or exceed those requirements before the Underwater Light is installed. Some of the NEC requirements are listed below.
 - a. The lighting circuit must have a Ground Fault Circuit Interrupter (GFCI), or for low voltage lights a listed swimming pool transformer, and have an appropriately rated circuit breaker.
 - b. The junction box or the low voltage transformer is located at least 8 inches above water level and at least 48 inches from the edge of the pool, see Figure 1.

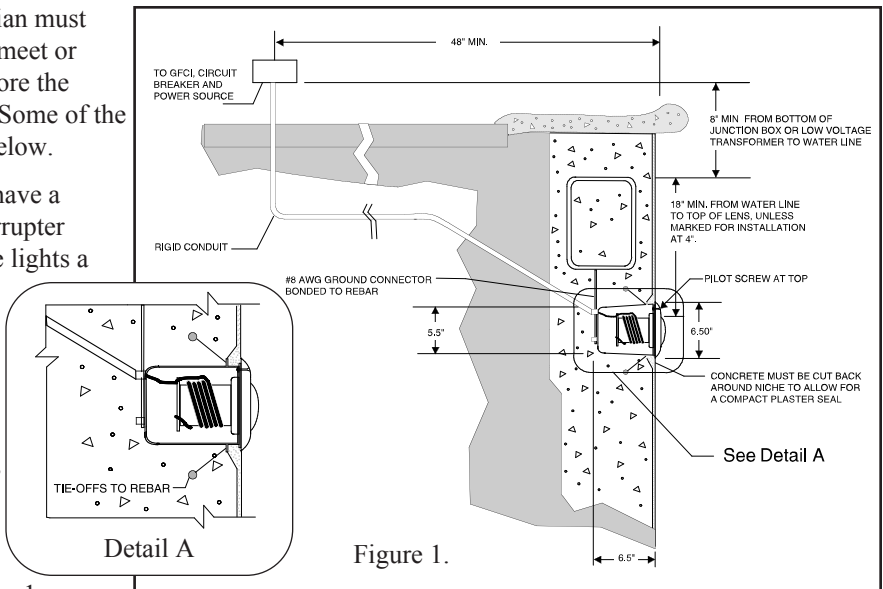

Pentair Pool Products

1620 Hawkins Ave., Sanford, NC 27330 • (919) 774-4151
10951 West Los Angeles Ave., Moorpark, CA 93020-8085 • (805) 523-2400

Rev. B 5-17-01
P/N 99791500

- c. The wet niche and all metal items within five (5) feet of the pool must be properly electrically bonded.
- d. The wet niche must be properly installed so that the top edge of the Underwater Light's lens is at least 4 inches below the surface of the water in the pool, see Figure 1.
- e. The wet niche must be properly electrically bonded and grounded via the NO. 8 AWG ground connector located at the rear of the niche, see Figure 1.

NOTE

The pool or spa electrical system can be verified with a Pool and Spa Electrical Qualification Test kit. The test kit is available from Pentair Pool Products. The electrical system inspection using the above kit must be performed by trained and certified personnel.

- 2. To be certain that the pool's electrical system meets all applicable requirements, you should also consult the local building department.
 - 3. Use only Pentair Pool Products wet niches with this light fixture to ensure proper bonding and grounding connections.
- B. Perform the following steps after the electrical system requirements are met.
- 1. Feed cord through conduit to junction box leaving at least four (4) feet of cord at the light fixture to coil around the light, see Figure 1. This four (4) feet of cord coiled around the light allows the light to be serviced after the pool is filled with water.
 - 2. Cut the cord at the junction box or the transformer/junction box, leaving at least 6 inches of cord to make connections.
 - 3. Strip six (6) inches of the outer cord jacket to expose the two insulated wires — Be careful not to damage the insulation on the two (2) inner wires.
 - 4. If connecting the Underwater Light to a junction box, connect the black wire of the light to power and the white wire to common. There is no ground wire coming from the light. See Table 1 to determine which voltage taps to use at the low voltage transformer connection.
 - a. If connecting the Underwater Light to an Pentair Pool Products Transformer/Junction Box unit, consult the instructions included with the Transformer/Junction Box unit to determine the correct wire connections.

Table 1. Determining Transformer Tap Voltage

Cord Gage	*Total Cord Length (ft.)	12 Volt Tap	13 Volt Tap	14 Volt Tap
18	15 - 20		X	
18	25 - 30			X
16	15	X		
16	20 - 30		X	
16	35 - 50			X
12	15 - 30	X		
12	35 - 65		X	
12	70 - 75			X

* Note: Total cord length is length of cord from the light to the junction box plus the length of cord from the junction box to the transformer.

- b. The cord gauge is indicated on the cord jackets.

	⚠ WARNING
<p>Never operate this Underwater Light for more than 10 seconds unless it is totally submerged in water. Without total submersion, the light assembly will get extremely hot, which may result in serious burns or in damage of the lamp or lens. This may result in serious injury to pool users, installers, or bystanders, or in damage to property.</p>	

- 5. Install the Underwater Light by rotating the light in a clockwise direction towards the niche, when viewed from front. Wrap the cord in a single layer around the light. Start wrapping the cord at the rear of the housing and work towards the face ring, see Figure 2.

6. When the Underwater Light is level with the niche secure the cord in the cord lock on the base of the light, see Figure 2.
7. Install the Underwater Light into the niche and tighten the special stainless steel pilot screw.
8. Fill pool until the Underwater Light is completely submerged in water before operating the light for more than 10 seconds. Turn on main switch or circuit breaker, as well as the switch which operates the Underwater Light itself, to check for proper operation.

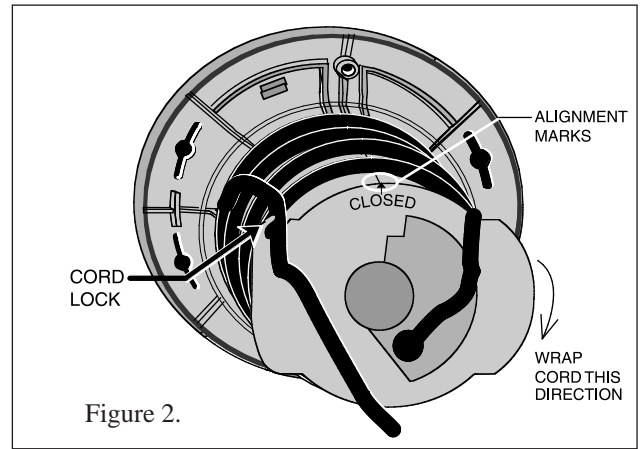

Figure 2.

Section II. Replacing light fixture in existing pools.

	<p>⚠ DANGER</p> <p>RISK OF ELECTRICAL SHOCK OR ELECTROCUTION</p> <p>This Underwater light fixture must be installed by a licensed or certified electrician or a qualified pool serviceman in accordance with the National Electrical Code and all applicable local codes and ordinances. Improper installation will create an electrical hazard which could result in death or serious injury to pool users, installers or others due to electrical shock and may also cause damage to property. Always disconnect power to the pool light at the circuit breaker before servicing the light. Failure to do so could result in death or serious injury to serviceman, pool users or others due to electrical shock.</p>
--	---

	<p>⚠ DANGER</p> <p>RISK OF ELECTRICAL SHOCK OR ELECTROCUTION</p> <p>This underwater low voltage light is designed for use with a low voltage transformer operating between 12 and 15 volts. Do not connect light directly to a 120 volt circuit as this could result in death or serious injury to pool users, installers, or bystanders, or in property damage.</p>
--	--

- A. Perform steps 1 through 3, (following), before replacing a light fixture.
 1. Ensure that the electrical system of your pool conforms with all requirements of the National Electrical Code (NEC), and all local codes and ordinances. A licensed or certified electrician must install the electrical system to meet or exceed those requirements before the Underwater Light is installed. Some of the NEC requirements are listed in items 1.a. through 1.d. below.
 - a. The lighting circuit must have a Ground Fault Circuit Interrupter (GFCI), or for low voltage lights a listed swimming pool transformer, and an appropriately rated circuit breaker.
 - b. The junction box or the low voltage transformer is located at least 8 inches above water level and at least 48 inches from the edge of the pool, see Figure 3.
 - c. The wet niche and all metal items within five (5) feet of the pool must be properly electrically bonded.
 - d. The wet niche is properly installed so that the top edge of the Underwater Light's lens is at least 4 inches below the surface of the water in the pool, see Figure 3.
 - e. The wet niche must be properly electrically bonded and grounded via the No.8 AWG ground connector located at the rear of the niche, see Figure 3.

NOTE

The pool or spa electrical system can be verified with a Pool and Spa Electrical Qualification Test kit. The test kit is available from Pentair Pool Products. The electrical system inspection using the above kit must be performed by trained and certified personnel.

2. To be certain that the pool's electrical system meets all applicable requirements, you should consult the local building department.
3. Install this light fixture only in an Pentair Pool Products wet niche. Wet niches made by other manufacturers may not provide proper bonding and grounding connections.

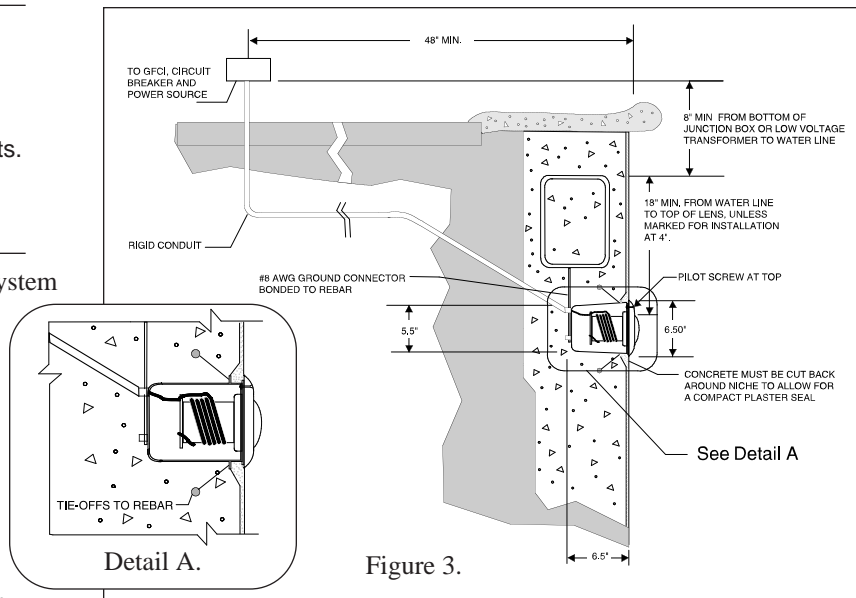

- B. Replacing light fixture after electrical system requirements are met.



WARNING

Failure to bring the pool's electrical system up to code requirements before installing this Underwater Light will create an electrical hazard which could result in death or serious injury to pool users, installers, or others due to electrical shock, and may also cause damage to property.

1. Turn off main electrical switch or circuit breaker, as well as the switch which operates the Underwater Light itself.
2. To remove light assembly, remove pilot screw at top of face ring, remove light assembly from niche, and place assembly on deck.
3. Remove junction box cover, disconnect the light fixture wires, and pull the cord through the conduit.
4. Feed the new light fixture cord through the conduit from the niche to the junction box.

NOTE

Special tools may be required to pull the cord through the conduit, depending on the length of the conduit.

5. Leave at least four (4) feet of cord to coil around the light fixture, see Figure 3. This four (4) feet of cord coiled around the light allows the light to be serviced after the pool is filled with water.
6. Cut the cord at the junction box, leaving at least six (6) inches of cord to make connections.
7. Strip six (6) inches of the outer cord jacket from the cord to expose the two insulated wires. Be careful not to damage the insulation on the two (2) inner wires.
8. If connecting the Underwater Light to a junction box, connect the black wire of the light to power and the white wire to common. There is no ground wire coming from the light. See Table 2 to determine which voltage taps to use at the low voltage transformer connection.
 - a. If connecting the Underwater Light to an Pentair Pool Products Transformer/Junction Box unit, consult the instructions included with the Transformer/Junction Box unit to determine the correct wire connections.

Table 2. Determining Transformer Tap Voltage

Cord Gage	*Total Cord Length (ft.)	12 Volt Tap	13 Volt Tap	14 Volt Tap
18	15 - 20		X	
18	25 - 30			X
16	15	X		
16	20 - 30		X	
16	35 - 50			X
12	15 - 30	X		
12	35 - 65		X	
12	70 - 75			X

* Note: total cord length is length of cord from the light to the junction box plus the length of cord from the junction box to the transformer.

- b. The cord gauge is indicated on the cord jackets.

	⚠ WARNING
	Never operate this Underwater Light for more than 10 seconds unless it is totally submerged in water. Without total submersion, the light assembly will get extremely hot, which may result in serious burns or in damage of the lamp or lens. This may result in serious injury to pool users, installers, or bystanders, or in damage to property.

9. Install the Underwater Light by rotating the light in a clockwise direction towards the niche, when viewed from front. Wrap the cord in a single layer around the light. Start wrapping the cord at the rear of the housing and work towards the face ring, see Figure 2.
10. When the Underwater Light is level with the niche secure the cord in the cord lock on the base of the light, see Figure 2.
11. Install the Underwater Light into the niche and tighten the special stainless steel pilot screw.
12. Fill pool until the Underwater Light is completely submerged in water before operating the light for more than 10 seconds. To check for proper operation turn on main switch or circuit breaker, as well as the switch which operates the Underwater Light itself.

III. Replacing a lamp only.

	⚠ DANGER
	RISK OF ELECTRICAL SHOCK OR ELECTROCUTION Always disconnect power to the pool light at the circuit breaker before servicing the light. Failure to do so could result in death or serious injury to installer, serviceman, pool users, or others due to electrical shock.

1. Turn off main electrical switch or circuit breaker, as well as the switch which operates the Underwater Light itself.
2. Materials required for installation procedure:
 - a. New O-ring seal (part number 792071).
 - b. New 12 volt, 75 watt, MR16 lamp (part number 791124).



WARNING

Replace lamp with a similar type and wattage. Failure to replace lamp with the same type of lamp will damage the light assembly and may cause an electrical hazard resulting in death or serious injury to pool users, installers, or others due to electrical shock, and may also cause damage to property.



WARNING

Always install a new O-ring seal (part number 79207100) whenever disassembling the light. Failure to do so may permit water to leak into the assembly which could cause an electrical hazard resulting in death or serious injury to pool users, installer, or others due to electrical shock, and may also cause property damage.

3. To remove light assembly, remove pilot screw at top of face ring, remove light assembly from niche, and place assembly on deck.
4. Unscrew the base of the light by rotating counterclockwise one quarter turn.
5. Remove and discard the old O-ring seal and lamp.
6. Install a new O-ring seal onto the base of the light. Make sure the O-ring seal is fully seated in the groove with no twists.
7. Install a new 12 volt, 75 watt, MR-16 lamp into the base of the light.
 - a. Be sure that the lamp is fully inserted into the base.
 - b. Be careful not to touch the bulb of the lamp with bare skin, as this will reduce the life of the bulb.



WARNING

Never operate this Underwater Light for more than 10 seconds unless it is totally submerged in water. Without total submersion, the light assembly will get extremely hot, which may result in serious burns or in breakage of the lamp or lens. This may result in serious injury to pool users, installers, or bystanders, or in damage to property.

8. Screw the base of the light into the light housing in a clockwise direction until the closed arrow on the base lines up with the mark on the housing. The light base will snap into place when it reaches the closed position, see Figure 4.
9. Install the Underwater Light by rotating the light in a clockwise direction towards the niche, when viewed from front. Wrap the cord in a single layer around the light. Start wrapping the cord at the rear of the housing and work towards the face ring, see Figure 4.
10. When the Underwater Light is level with the niche secure the cord in the cord lock on the base of the light, see Figure 4.
11. Install the Underwater Light into the niche and tighten the special stainless steel pilot screw.
12. Fill pool until the Underwater Light is completely submerged in water before operating the light for more than 10 seconds. To check for proper operation turn on main switch or circuit breaker, as well as the switch which operates the Underwater Light itself.

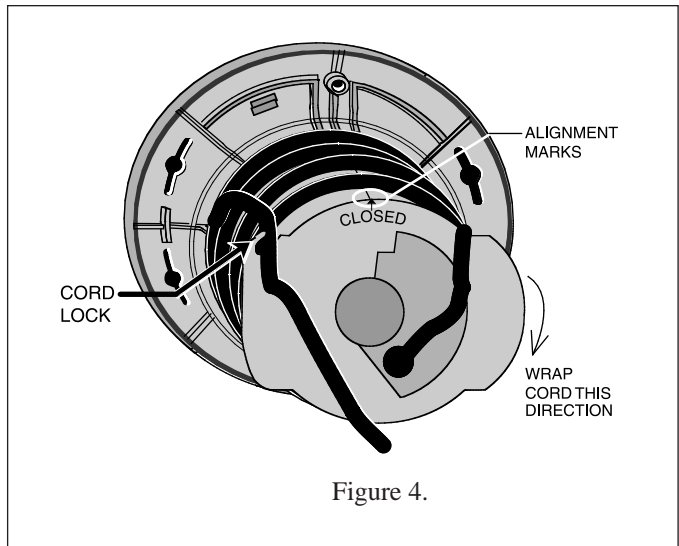
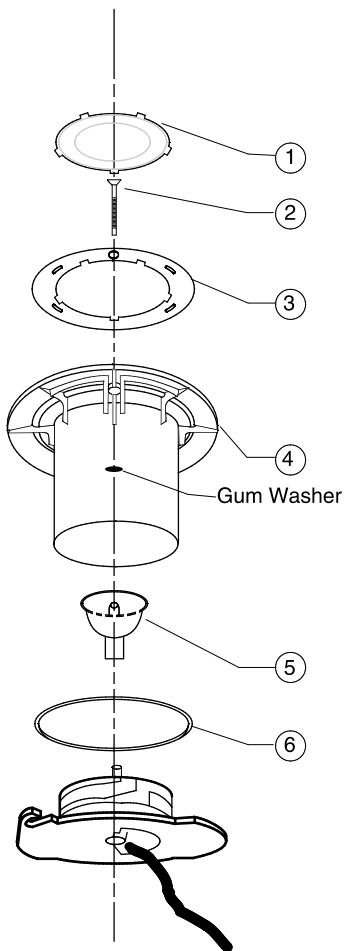

Figure 4.

ITEM NO.	DESCRIPTION	PART NO.
1	Colored Lens, Blue	79105401
	Colored Lens, Red	79105402
2	Pilot Screw with Gum Washer	79104800
3	Decorative Face Ring, White	79210000
	Decorative Face Ring, Grey	79210065
	Decorative Face Ring, Black	79210011
4	Housing Assy. with Instructions	79207000
5	75 Watt, 12 Volt, MR-16 Lamp	79112400
6	O-Ring with Instructions	79207100

SAVE THESE INSTRUCTIONS

Pentair Pool Products

1620 Hawkins Ave., Sanford, NC 27330 • (919) 774-4151
10951 West Los Angeles Ave., Moorpark, CA 93020-8085 • (805) 523-2400

Rev. B 5-17-01
P/N 99791500



Pentair
Pool Products™

Because reliability matters most